

# EXILIM

Digital Camera

## EX-S2/EX-M2

### User's Guide



E

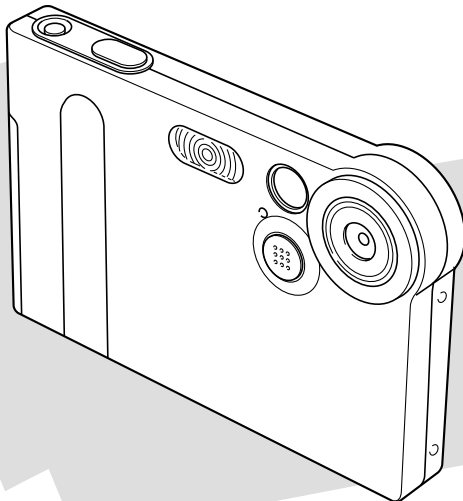

EX-M2

Thank you for purchasing this CASIO Product. Before using it, be sure to read the precautions contained in this User's Guide, and keep the User's Guide in a safe place for future reference.

All the illustrations in this manual show the EX-M2. See the text that accompanies the illustrations for information about how the EX-S2 and EX-M2 differ from each other.

# CASIO®

# INTRODUCTION

## Unpacking

Check to make sure that all of the items shown below are included with your camera. If something is missing, contact your dealer as soon as possible.

Camera



EX-M2

Rechargeable lithium ion battery (NP-20)

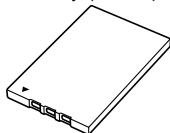

USB Cradle

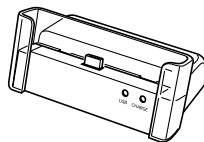

Special AC Adaptor

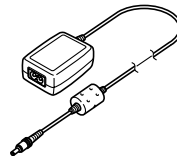

AC power cord \*

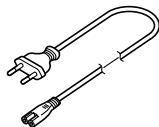

Strap

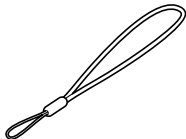

CD-ROM

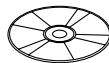

Special USB Cable

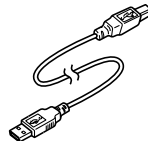

Dummy Card

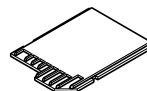

\* Loaded in the camera when you purchase it.

Connector Cover



\* Attached to the camera when you purchase it.

LCD Remote Controller



\* Comes with EX-M2 only

Stereo Headphones



\* Comes with EX-M2 only

Basic Reference

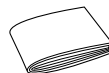

Rechargeable Lithium Ion Battery User's Guide



\* The shape of the AC power cord plug varies according to country or geographic area. The shape of the supplied AC power cord plug is shown on the package.

## Contents

**2 INTRODUCTION**

Unpacking .....	2
Features .....	8
Precautions .....	9
General Precautions	9
Data Error Precautions	11
Operating conditions	11
Condensation	12
LED Backlight	12
Lens	12
Other	13

**14 QUICK START GUIDE**

Getting Ready .....	14
Configuring Display Language and Clock Settings ...	15
To record an image .....	15
To view a recorded image .....	16
To delete an image .....	16

**17 GETTING READY**

General Guide .....	17
Camera	17
USB Cradle	18
Using the Controller .....	19
Monitor Screen Contents .....	20
Indicator Lamps .....	22
Attaching the Strap .....	22
Power Requirements .....	23
To load the battery	23
To charge the battery	24
Power Supply Precautions	28
Turning the Camera On and Off	29
Auto Power Off (APO)	29
Using the On-screen Menus .....	30
Configuring Display Language and Clock Settings ...	32

**34 BASIC IMAGE RECORDING**

Recording an Image .....	34
About the REC Mode Monitor Screen	35
Recording Precautions	35

## INTRODUCTION

Using Zoom .....	36
Using the Flash .....	37
Flash Precautions .....	38
Using the Self-timer .....	39
Specifying Image Size and Quality .....	40
To specify the image size .....	40
To specify the image quality .....	41

## 42 OTHER RECORDING FUNCTIONS

Exposure Compensation (EV Shift) .....	42
Adjusting the White Balance .....	43
Adjusting White Balance Manually .....	44
Using the Best Shot Mode .....	45
Using the Movie Mode .....	46
Recording Audio (EX-M2 Only) .....	48
Adding Audio to a Snapshot .....	48
Recording Your Voice .....	49
REC Mode Camera Settings .....	51
Turning the Monitor Screen On and Off .....	51
Turning Image Review On and Off .....	51
Assigning Functions to the Controller .....	52
Specifying Power On Default Settings .....	53

## 54 PLAYBACK

Basic Playback Operation .....	54
Playing an Audio Snapshot (EX-M2 Only) .....	55
Zooming the Displayed Image .....	56
Resizing an Image .....	57
Playing a Movie .....	58
Adding Audio to a Snapshot (EX-M2 Only) .....	59
To re-record audio .....	60
Playing Back a Voice Recording File (EX-M2 Only) ...	61

## 62 DELETING FILES

Deleting a Single File .....	62
Deleting All Files .....	63

## 64 FILE MANAGEMENT

Folders .....	64
Memory Folders and Files .....	64
Protecting Files .....	65
To protect a single file .....	65
To protect all files in memory .....	66

## INTRODUCTION

DPOF .....	66
To insert the date during printing .....	67
To configure print settings for a single image .....	67
To configure print settings for all images .....	68
PRINT Image Matching II .....	69
Exif Print .....	69
Using the FAVORITE Folder .....	70
To copy a file to the FAVORITE folder .....	70
To display a file in the FAVORITE folder .....	71
To delete a file from the FAVORITE folder .....	71

## 72 OTHER SETTINGS

Turning the Key Tone On and Off .....	72
Specifying an Image for the Startup Screen .....	72
Changing the Date and Time Setting .....	73
Changing the Date Format .....	74
Changing the Display Language .....	74
Formatting Built-in Memory .....	75

## 76 USING A MEMORY CARD

Using a Memory Card .....	77
To insert a memory card into the camera .....	77
To remove a memory card from the camera .....	77
Formatting a Memory Card .....	78
Memory Card Precautions .....	79
Copying Files .....	79
To copy all the files in built-in memory to a memory card .....	79
To copy a file from a memory card to built-in memory .....	80

## 81 USING THE CAMERA WITH A COMPUTER

Installing the Software from the CD-ROM .....	81
About the bundled CD-ROM .....	81
Computer System Requirements .....	82
Installing Software from the CD-ROM in Windows ...	83
Getting Started .....	83
Selecting a Language .....	83
Viewing the Contents of the "Read me" File .....	84
Installing an Application .....	84
Viewing User Documentation (PDF Files) .....	85
Exiting the Menu Application .....	85
Installing Software from the CD-ROM on a Macintosh .....	85
Installing Software .....	85
Viewing User Documentation (PDF Files) .....	88

## INTRODUCTION

Transferring Files to a Computer .....	89
Transferring Files Over a USB Connection	89
Using a Memory Card to Transfer Images to a Computer	92
Memory Data	93
Memory Directory Structure	94
Image Files Supported by the Camera	95
Built-in Memory and Memory Card Precautions	95

## 96 PLAYING AN AUDIO FILE (EX-M2 Only)

Transferring Audio Files to the Camera .....	96
Preparing the Camera for Audio Player Operation ...	97
Using the Camera as an Audio Player .....	98
General Guide	98
Basic Remote Controller Operations	100
Specifying the Audio Playback Mode	101
Selecting a Specify Track for Playback	101
Specifying the Track Playback Sequence	102
Disabling Remote Controller Button Operations	104
LCD Remote Control Error Messages .....	105
Audio Playback Precautions .....	105

## 106 APPENDIX

Menu Reference .....	106
Indicator Lamp Reference .....	107
Camera Indicator Lamps	107
USB Cradle Indicator Lamps	109
Troubleshooting Guide .....	110
Display Messages	113
Specifications .....	114
Main Specifications	114

### ▶▶ IMPORTANT! ▶▶

- The contents of this manual are subject to change without notice.
- CASIO COMPUTER CO., LTD. assumes no responsibility for any damage or loss resulting from the use of this manual.
- CASIO COMPUTER CO., LTD. assumes no responsibility for any loss or claims by third parties which may arise through the use of the EX-S2/EX-M2.
- CASIO COMPUTER CO., LTD. shall not be held liable for any damages or losses suffered by you or any third party due to the use of Photo Loader and/or Photohands.
- CASIO COMPUTER CO., LTD. assumes no responsibility for any damage or loss caused by deletion of data as a result of malfunction, repairs, or battery replacement. Be sure to back up all important data on other media to protect against its loss.
- *The SD logo is a registered trademark.*
- *Windows, Internet Explorer, and DirectX are registered trademarks of Microsoft Corporation.*
- *Macintosh is a registered trademark of Apple Computer, Inc.*
- *MultiMediaCard is a trademark of Infineon Technologies AG of Germany, and licensed to the MultiMediaCard Association (MMCA).*
- *Acrobat and Acrobat Reader are trademarks of Adobe Systems Incorporated.*

- *The USB driver (mass storage) uses Phoenix Technologies Ltd. software.  
Compatibility Software Copyright © 1997  
Phoenix Technologies Ltd., All Rights Reserved.*
- *MPEG Layer-3 audio decoding technology licensed from Fraunhofer IIS and Thomson multimedia.*
- *Other company, product and service names used herein may also be trademarks or service marks of others.*
- *Photo Loader and Photohands are the property of CASIO COMPUTER CO., LTD. Except as stipulated above, all copyrights and other related rights to these applications revert to CASIO COMPUTER CO., LTD.*

### ■ Copyright Restrictions

Except for the purposes of your own personal enjoyment, unauthorized copying of snapshot files, movie files, audio files, and music files violates copyright laws and international contracts. Distribution to third parties of such files over the Internet without permission of the copyright holder, whether for profit or for free, violates copyright laws and international contracts.

### Features

- **2.0 million Effective Pixels**  
A high-resolution megapixel CCD provides 2.0 million effective pixels (2.11 million total pixels) for images that print beautifully.
  - **Fixed focus lens for quick operation**  
Fixed focus eliminates the need for lens movement, which shortens startup time and shooting time.
  - **1.6-inch TFT color LCD monitor screen**
  - **4X digital zoom**
  - **12MB flash memory**  
Images can be recorded without using a memory card.
  - **Support for SD memory cards and MMC (MultiMedia Cards) for memory expansion**
  - **Easy Charging**  
Just place the camera onto the USB cradle to charge its battery.
  - **Easy Image Transfer**  
Transfer images to a computer simply by placing the camera onto the USB cradle.
- **Best Shot**  
Simply select the sample scene that matches the type of image you are trying to record and the camera performs troublesome setups automatically for beautiful pictures every time.
  - **DCF Data Storage**  
DCF (Design rule for Camera File system) data storage



## INTRODUCTION

### \* EX-M2 Only

- Snapshot + Audio Mode  
Adds audio to a snapshot.
- Movie + Audio Mode
- Voice Recording  
Quick and easy recording of voice input.
- After Recording  
Adds audio to images after they are recorded.
- Audio Player Capabilities  
Use the camera to play back music data from standard MP3 (MPEG-1 Audio Layer-3) files.

## Precautions

### General Precautions

Be sure to observe the following important precautions whenever using the EX-S2/EX-M2.

All references in this manual to “this camera” and “the camera” refer to the CASIO EX-S2/EX-M2 Digital Camera.

- Never try to take pictures or use the built-in display while

## INTRODUCTION

- Never fire the flash while it is too close to the subject's eyes. Intense light from the flash can cause eye damage if it is fired too close to the eyes, especially with young children. When using the flash, the camera should be at least one meter from the eyes of the subject.
- Keep the camera away from water and other liquids, and never let it get wet. Moisture creates the danger of fire and electric shock. Never use the camera outdoors in the rain or snow, at the seashore or beach, in the bathroom, etc.
- Should foreign matter or water ever get into the camera, immediately turn power off, unplug the AC adaptor power cord from the power outlet, and contact your dealer or nearest CASIO authorized service center. Using the camera under these conditions creates the danger of fire and electric shock.
- Should you ever notice smoke or a strange odor coming out of the camera, immediately turn power off and unplug the AC adaptor power cord from the power outlet. Using the camera under these conditions creates the danger of fire and electric shock. After making sure there is no more smoke coming from the camera, take it to your nearest CASIO authorized service center for repair. Never attempt your own maintenance.
- Never use the AC adaptor to power any other device besides this camera. Never use any other AC adaptor besides the one that comes with this camera.
- Never cover the AC adaptor with a quilt, blanket, or other cover while it is in use, and do not use it near a heater.
- At least once a year, unplug the AC adaptor power cord from the power outlet and clean the area around the prongs of the plug. Dust build up around the prongs can create the danger of fire.
- If the camera's case should ever become cracked due to dropping it or otherwise subjecting it to rough treatment, immediately turn power off, unplug the AC adaptor power cord from the power outlet, and contact your nearest CASIO authorized service center.
- Never use the camera inside of an aircraft or in any other areas where its use is prohibited. Doing so can result in an accident.
- Physical damage and malfunction of this camera can cause the data stored in its memory to be deleted. Be sure to always keep backup copies of data by transferring them to personal computer memory.
- Never open the battery cover, disconnect the AC adaptor from the camera or unplug it from the wall socket while recording images. Doing so will not only make storage of the current image impossible, it can also corrupt other image data already stored in camera memory.

### Data Error Precautions

- Your digital camera is manufactured using precision digital components. Any of the following creates the risk of corruption of data in camera memory.
  - Removing the battery while image recording or data communication is in progress.
  - Removing a memory card while image recording is in progress.
  - Removing the battery, removing the memory card, or placing the camera onto the USB cradle while the operation/flash charge lamp is still flashing after you turn off the camera.
  - Disconnecting the USB cable, removing the camera from the USB cradle, or disconnecting the AC adaptor from the USB cradle while a data communication operation is being performed.
  - Using low battery.
  - Other abnormal operations.

Any of the above conditions can cause an error message to appear on the monitor screen (page 113). Follow the instructions provided by the message to correct the situation.

### Operating conditions

- This camera is designed for use in temperatures ranging from 0°C to 40°C.
- Do not use or keep the camera in the following areas.
  - In areas subject to direct sunlight
  - In areas subject to high humidity or dust
  - Near air conditioners, heaters, or other areas subject to temperature extremes
  - Inside of a closed vehicle, especially one parked in the sun
  - In areas subject to strong vibration

### Condensation

- When you bring the camera indoors on a cold day or otherwise expose it to a sudden change of temperature, there is the possibility that condensation can form on the exterior or on interior components. Condensation can cause malfunction of the camera, so you should avoid exposing it to conditions that might cause condensation.
- To keep condensation from forming, place the camera into a plastic bag before moving it into a location that is much warmer or colder than your current location. Leave it in the plastic bag until the air inside the bag has a chance to reach the same temperature as the new location. If condensation does form, remove the battery from the camera and leave the battery cover open for a few hours.

### LED Backlight

- The monitor screen is illuminated by an LED backlight. A dark monitor screen indicates that the LED backlight has reached the end of its service life, and needs to be replaced by a CASIO authorized service center. Note that you will be charged for LED backlight replacement. The LED backlight brightness is reduced by half after about 1,000 hours of use.

### Lens

- Never apply too much force when cleaning the surface of the lens. Doing so can scratch the lens surface and cause malfunction.
- Fingerprints, dust, or any other soiling of the lens can interfere with proper image recording. Never touch the lens with your fingers. You can remove dust particles from the lens surface by using a lens blower to blow them off. Next, wipe the surface of the lens with a soft lens cloth.

### Other

- The camera may become slightly warm during use. This does not indicate malfunction.

# QUICK START GUIDE

## Getting Ready

### 1. Load the battery (page 23).

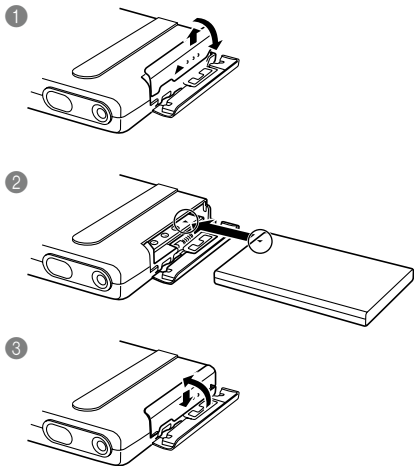

### 2. Place the camera onto the USB cradle to charge the battery (page 24).

- It takes about two hours to achieve a full charge.

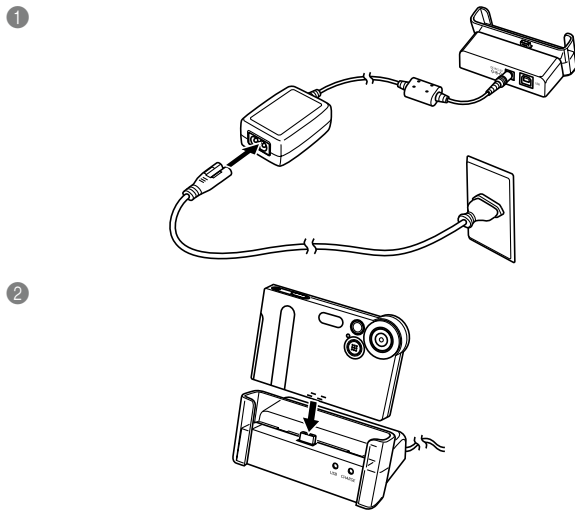

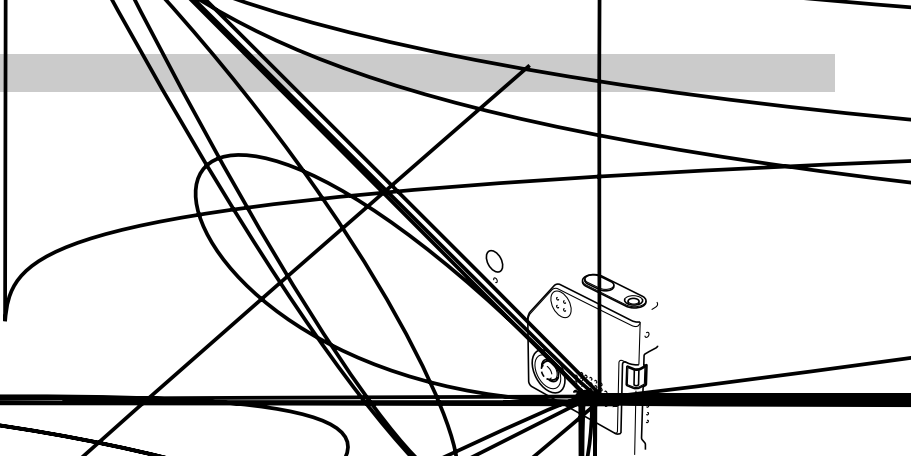

- 1. Press the power button to turn on the camera.**
- 2. Align the mode selector with “REC”.**
- 3. Point the camera at the subject, and use the monitor screen or viewfinder to compose the image.**
- 4. Holding the camera still, gently press the shutter release button.**

era.



...ent to scroll through  
...e you want to delete.

...or down to select "Delete".

...lete operation without deleting any-  
...el".

...roller to delete the selected image.



# GETTING READY

This section contains about things you need to know about and do before trying to use the camera.

## General Guide

The following illustrations show the names of each component, button, and switch on the camera.

### Camera

#### ■ Front

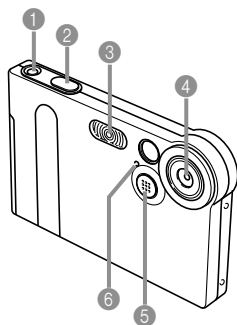

- ① Power button
- ② Shutter release button
- ③ Flash
- ④ Lens
- ⑤ Microphone  
(EX-M2 only)
- ⑥ Self-timer lamp

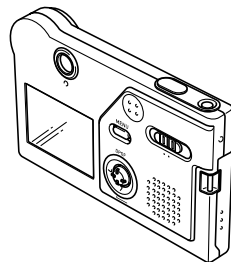

### ■ Bottom

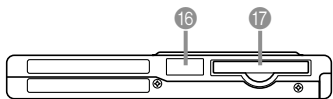

16 Connector cover

17 Memory card slot

If you are not using a memory card, be sure to insert the dummy card into this slot to protect against dust and damage.

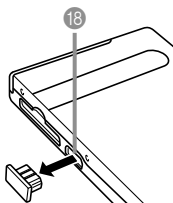

## Using the Controller

The controller is used to select on-screen items and to execute functions. The following are the terms used in this manual to describe controller operations.

Term	Meaning
Rock	Use your thumb to push the controller up, down, left, or right.
Click	Use your thumb to press straight down on the controller until it clicks.

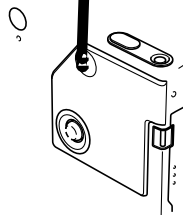

## Monitor Screen Contents

The monitor screen uses various indicators and icons to keep you informed of the camera's status.

### REC Mode

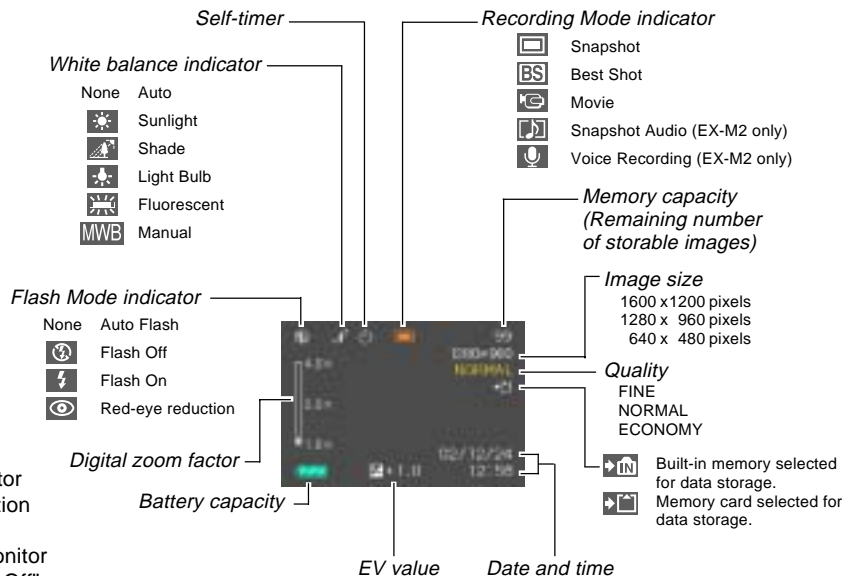

### NOTE

- You can turn display of monitor screen information on and off. See "Turning the Monitor Screen On and Off" on page 51 for more information.

## ■ PLAY Mode

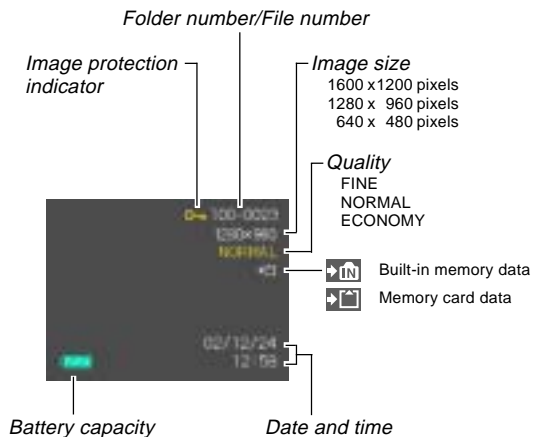

## ▶▶ IMPORTANT! ◀◀

- Some information may not display properly if you display an image that was recorded using a different digital camera model.

### Indicator Lamps

You can find out the operational status of the camera and the USB cradle at a glance by checking the color of the indicator lamps, and whether a lamp is lit or flashing. For details, see “Indicator Lamp Reference” on page 107.

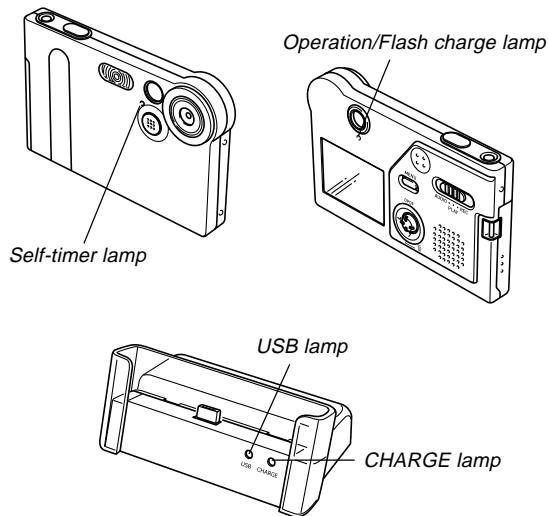

### Attaching the Strap

Attach the strap to the strap bar as shown in the illustration.

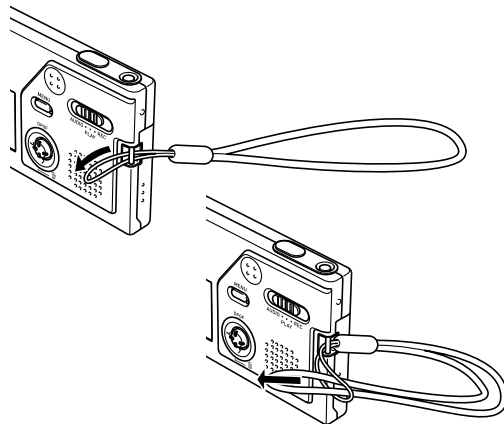

### ►► IMPORTANT! ◀◀

- Be sure to keep the strap around your wrist when using the camera to protect against accidentally dropping it.
- The supplied strap is intended for use with this camera only. Do not use it for any other purpose.
- Never swing the camera around by the strap.

## Power Requirements

Your camera is powered by a rechargeable lithium ion battery (NP-20).

### To load the battery

1. Pressing the battery cover on the side of the camera, slide it in the direction indicated by the ▲ mark and then swing it open.

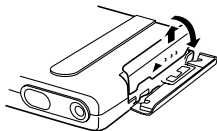

2. Align the arrow mark on the battery with the arrow mark on the camera as shown in the illustration, and slide the battery into the battery compartment.

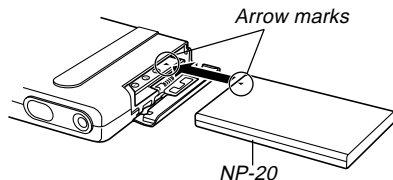

3. Swing the battery cover closed, and then slide it in the direction indicated by the arrow while pressing down on it.

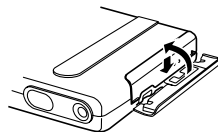

#### IMPORTANT!

- Use only the special NP-20 rechargeable lithium ion battery to power this camera. Use of any other type of battery is not supported.

#### NOTE

- To remove the battery, open the battery cover. Taking care that the battery does not suddenly fall out of the camera, tilt the camera towards the side. When the battery slides out part way, pull it out by hand.

The battery is not charged when you purchase the camera. You need to charge the battery before using the camera for the first time.

## To charge the battery

1. Connect the AC power cord to the AC adaptor.
2. Plug the other end of the AC power cord into a household power outlet.
3. Connect the AC adaptor to the DC IN 5.3V connector of the USB cradle.

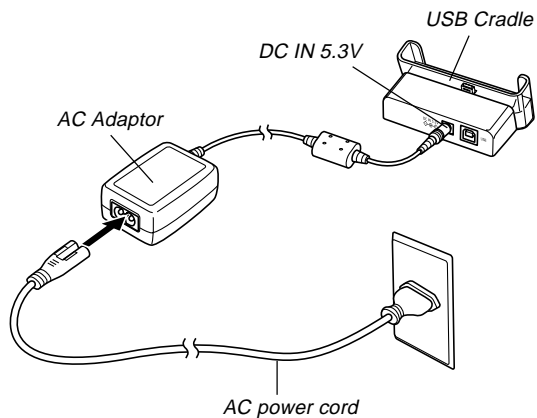

4. Turn off the camera and remove its connector cover.

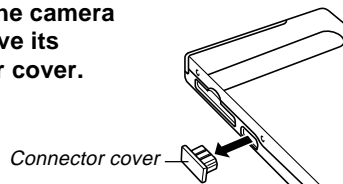

5. Set the camera onto the USB cradle.

- The CHARGE lamp on the USB cradle should turn red, indicating that charging has started. When charging is complete, the CHARGE lamp will turn green.

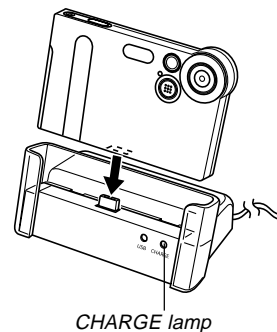

6. After charging is complete, remove the camera from the USB cradle and replace the connector cover.



### ▶▶ IMPORTANT! ◀◀

- It takes about two hours to achieve a full charge. Actual charging time depends on current battery capacity and charging conditions.
- Use only the USB cradle to charge the special NP-20 rechargeable lithium ion battery. Never use any other charger device.
- Use only the bundled AC adaptor. Never use any other type of AC adaptor. Do not use optionally available AD-C620 and AD-C630 AC adaptors with this camera.
- Make sure that the camera connector of the USB cradle is securely inserted into the camera's connector as far as it will go.
- The CHARGE lamp may remain amber colored and the charge operation may not start right away if you try to charge immediately after using the camera (which causes battery to become warm) or when it is too hot or too cold where you are performing the charge operation. If this happens, simply wait until the battery reaches normal temperature. The CHARGE lamp will turn red and charging will start when the battery temperature returns to the allowable charging temperature range.

- The CHARGE lamp flashing red indicates that an error occurred while charging. An error can be caused by any of the following: a problem with the cradle, a problem with the camera, or a problem with the battery or how it is loaded. Remove the camera from the cradle and see if it works normally.
- The USB cradle can be used for charging or USB data communication only.

### ▶▶ NOTE ◀◀

- USB cradle is designed for operation with any power supply in the range of 100V to 240V AC. Note, however, that the shape of the hic7 torid plug varies by youation.ere plle to hot otgeograp ( youa,.ere need hot

## ■ If the camera works normally

1. Continue using the camera until the current charge is used up, and then charge the battery.

## ■ If the camera does not work normally

This can mean there is a problem with how the battery is loaded.

1. Remove the battery from the camera and check the battery contacts for dirt. If the contacts are dirty, wipe them clean with a dry cloth.
2. Check to make sure that the AC adaptor's power cord is connected securely to the power outlet and cradle.
  - If the same symptoms occur again when you place the camera on the cradle after taking the above steps, contact a CASIO authorized service center.

## ■ Battery Life Guidelines

The battery life guideline values given below indicate the amount of time at standard temperature (25°C) until power automatically turns off due to battery failure. They do not guarantee that the battery will provide the amount of service indicated. Low temperatures and continued use reduce battery life.

Operation	Approximate Battery Life
Continuous Recording* <sup>1</sup>	65 minutes (390 shots)
Continuous Playback* <sup>2</sup> (Continuous Snapshot Recording)	110 minutes
Continuous Voice Recording* <sup>3</sup>	80 minutes
Continuous Audio Playback* <sup>3</sup>	330 minutes

### \*1 Continuous Recording Conditions

- Normal temperature: 25°C (77°F)
- Flash: Off
- Monitor screen: Off
- Image recorded about every 10 seconds

### \*2 Continuous Playback Conditions

- Normal temperature: 25°C (77°F)
- Scroll one image about every 10 seconds

\*3 Voice recording and audio playback times apply to the EX-M2 only.



- Recording one image per minute under the above conditions reduces battery life to about one sixth of that noted above.
- Voice recording times are based on continuous recording, while audio playback times are based on continuous output (through headphones).
- The above values are based a new battery starting from a full charge. Repeated charging shortens battery life.
- Battery life is greatly affected by how much you use flash, zoom and other functions, and how long you leave power turned on.

### ■ Tip to Make the Battery Last Longer

If you do not need the flash while recording, use the menu to select  (flash off) for the flash mode. See page 37 for more information.

### ■ Low Battery Indicator

The following shows how the battery capacity indicator on the monitor screen changes as battery power is used. If you continue to use the camera while the battery level is , camera power will automatically turn off. When this happens, charge the battery as soon as possible.

Battery Level	High	←————→	Low		
Indicator		→		→	

## Power Supply Precautions

### ■ Battery Precautions

See the instructions that come with the rechargeable lithium ion battery (NP-20) for important precautions you need to observe during its use.

### ■ USB Cradle and AC Adaptor Precautions



Caution!

- Never use an electrical outlet whose voltage is outside the rating marked on the AC adaptor. Doing so can create the danger of fire or electric shock. Use only the bundled AC adaptor specified for this camera.
- Do not allow the AC adaptor cord to become cut or damaged, do not place heavy objects on it, and keep it away from heat. A damaged power cord creates the risk of fire and electric shock.
- Never try to modify the AC adaptor cord, or subject it to severe bending, twisting, or pulling. Doing so creates the risk of fire and electric shock.
- Never touch the AC adaptor while your hands are wet. Doing so creates the risk of electric shock.

- Do not overload extension cords or wall outlets. Doing so creates the danger of fire and electric shock.
- Should the cord of the AC adaptor become damaged (exposed internal wiring), request a replacement from a CASIO authorized service center. A damaged AC adaptor cord creates the danger of fire or electric shock.

- Make sure you always remove the camera from the USB cradle before connecting or disconnecting the AC adaptor.
- Charging and USB data communication can cause the AC adaptor to become warm. This is normal and does not indicate malfunction.
- Unplug the AC power cord from the power outlet whenever you are not using it.
- Never place a blanket or any other cover on the AC adaptor. Doing so creates the risk of fire.

## Turning the Camera On and Off

Press the power button to turn the camera on and off.

Pressing the power button to turn on the camera causes the operation/flash charge lamp to turn green. Press the power button again to turn off the camera.

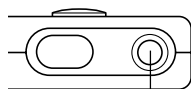

Power button

### ▶▶ IMPORTANT! ◀◀

- If camera power is turned off by the Auto Power Off feature, press the power button to turn it back on again.

## Auto Power Off (APO)

Auto Power Off (APO) automatically turns off the camera when you do not perform any operation for certain amount of time. The amount of time that needs to pass before APO is triggered depends on the mode the camera is in.

Mode	Approximate Time to APO
REC	2 minutes
PLAY	2 minutes
AUDIO (EX-M2 only)	10 seconds

## Using the On-screen Menus

Pressing MENU displays menus on the monitor screen that you can use to perform various operations. The menu that appears depends on whether you are in the REC mode or the PLAY mode. The following shows an example menu procedure in the REC mode.

### 1. Turn on the camera, and then align the mode selector with "REC" to enter the REC mode.

- If you want to enter the PLAY mode instead, you would align the mode selector with "PLAY".

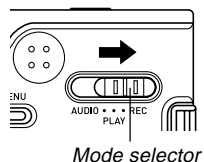

### 2. Press MENU.



*Settings*

Selection cursor (indicates the currently selected item)

## ● Menu Screen Operations

When you want to do this:	Do this:
Move between tabs	Rock the controller left or right
Move from the tab to the settings	Rock the controller down
Move between the settings	Rock the controller up or down
Display the options available for a setting	Rock the controller right or click the controller
Select an option	Rock the controller up or down
Register an option selection and exit the menu screen	Click the controller
Register an option selection and return to the menu screen	Rock the controller left
Exit the menu screen	Press MENU

**3. Rock the controller left or right to select the tab you want, and then rock it down to move the selection cursor from the tab to the settings.**

- If you ever need to move the selection cursor back from the settings to the tabs, rock the controller up until the cursor reaches the top of the menu.

**4. Rock the controller up or down to select the setting you want to change, and then rock the controller to the right.**



*Example: "Flash" setting selected.*

- This displays a submenu of options available for the selected setting.
- Instead of rocking the controller, you could also click it.

**5. Rock the controller up or down to select the option you want, and then click.**

**6. Next, do either of the following.**

If you want to do this:	Do this:
Apply the setting and exit the menu screen	Click the controller.
Apply the setting and return to menu screen to change other settings	Rock the controller left.

- See "Menu Reference" on page 106 for more information about menus.

### Configuring Display Language and Clock Settings

Be sure to configure the following settings before using the camera to record images.

- Display language
- Date and time

Note that the current date and time settings are used by the camera to generate the date and time that are stored along with image data, etc.

### ▶▶ IMPORTANT! ◀◀

- The camera's clock settings are cleared whenever power is totally cut off. This can happen if the battery goes dead while the camera is not being supplied power by the USB cradle. The clock setting screen will appear automatically the next time you turn on power after the settings are cleared. Set the date and time before using the camera.
- The current date and time settings will be cleared if the battery remains dead without being charged for about one day.
- Recording images without configuring the clock settings causes incorrect time information to be registered. Be sure to configure the clock settings before using the camera.



## GETTING READY

1. Press the power button to turn on the camera.
2. Rock the controller up or down to select the language you want.  
日本語 : Japanese  
English : English  
Français : French  
Deutsch : German  
Español : Spanish  
Italiano : Italian
3. Click to register the language setting and advance to the clock settings.

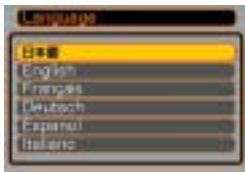

4. Set the date and the time.



To do this:	Do this:
Change the setting at the current cursor location	Rock the controller up or down.
Move the cursor between settings	Rock the controller left or right.

5. Click to register the clock settings and exit the setting screen.

### 3. Compose the image on the monitor screen.

- The focusing range of the camera is approximately 1 meter to infinity ( $\infty$ ).
- When performing this step, take care so your fingers do not block the lens or any of the sensors.
- You can compose images using either the monitor screen or the optical viewfinder.
- When using the optical viewfinder, you can turn off the monitor screen to save power (page 51).

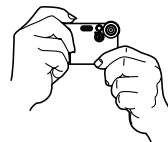
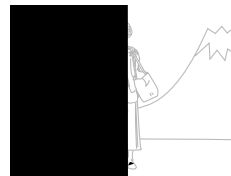

### 4. Press the shutter release button to record the image.

- The number of images that can be stored in memory depends on the resolution setting you are using (pages 40, 114).

- Depending on the distance or angle between the subject and the camera, the image you see in the viewfinder may not be exactly the image that is recorded.
- Press the shutter release gently to avoid camera movement.

### About the REC Mode Monitor Screen

- The image shown on the monitor screen in the REC mode is a simplified image for composing purposes. The actual image is recorded in accordance with the image quality setting currently selected on your camera. The image saved on memory has much better resolution and detail than the REC mode monitor screen image.
- Certain levels of subject brightness can cause the response of the REC mode monitor screen to slow down, which causes some static noise in the monitor screen image.

### Recording Precautions

- Never open the battery cover or place the camera onto the USB cradle while the operation/flash charge lamp is flashing green. Doing so not only causes the current image to be lost, it can also corrupt images already stored in camera memory and even lead to malfunction of the camera.
- Never remove the memory card while an image is being recorded to the memory card.
- Fluorescent lighting actually flickers at a frequency that cannot be detected by the human eye. When using the camera indoors under such lighting, you may experience some brightness or color problems with recorded images.
- The camera automatically adjusts its sensitivity in accordance with the brightness of the subject. This can cause some static noise to appear in images of relatively dark subjects.
- For a dimly lit subject, the camera raises the sensitivity and uses a faster shutter speed. Because of this, you need to guard against camera movement if you have flash turned off (page 37) when recording a dimly lit subject.
- If unwanted light is shining on the lens, shade the lens with your hand when recording the image.

## Using Zoom

You can use the digital zoom feature of your camera to zoom in on the center of an image. Performing a zoom operation toggles the zoom factor between 1X and 4X.

1. In the REC mode, press MENU.
2. Rock the controller left or right to select the "REC" tab.
3. Rock the controller up or down to select "Digital Zoom", and then rock the controller to the right.
4. Rock the controller up or down to select "On", and then click.
  - Selecting "Off" in step 4 disables digital zoom.

5. Rock the controller up or down in the REC mode to change the digital zoom factor.

Rock up to zoom in.

Rock down to zoom out.

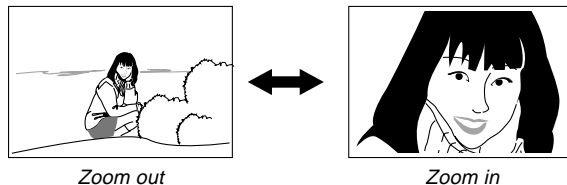

6. Record the image.

### ►► IMPORTANT! ◀◀



- Zoom is disabled whenever the monitor screen is turned off (page 51).
- To disable digital zoom, select "Off" for the "Digital Zoom" setting on the "REC" tab.

### Using the Flash

Perform the following steps to select the flash mode you want to use.

1. In the REC mode, press MENU.
2. Rock the controller left or right to select the “REC” tab.
3. Rock the controller up or down to select “Flash”, and then rock the controller to the right.
4. Rock the controller up or down to select the flash mode you want, and then click.



To do this:	Select this setting:
Have the flash fire automatically when required (Auto Flash)	Auto
Turn off the flash (Flash Off)	
Always fire the flash (Flash On)	
Fire a pre-flash followed by image recording with flash, reducing the chance of red-eye in the image (Red-eye reduction). Have the flash fire automatically when required.	

### 5. Record the image.

#### !!! IMPORTANT! !!!

- The flash unit of this camera fires a number of times when you record an image. The initial flashes are pre-flashes, which the camera uses to obtain information it uses for exposure settings. The final flash is for recording. Make sure that you keep the camera still until the shutter releases.
- Image recording may not be performed if you press the shutter release button while the operation/flash charge lamp is flashing amber.

### NOTE

- You can use the key customization feature (page 52) to configure the camera so the flash mode changes whenever you rock the controller left or right while in the REC mode.

### About Red-eye Reduction

Using the flash to record at night or in a dimly lit room can cause red spots inside the eyes of people who are in the image. This is caused when the light from the flash reflects off of the retina of the eye. Red-eye reduction fires a pre-flash, which causes the irises in the eyes of any people in the image to close. This is followed by another flash operation when the image is actually recorded.

### IMPORTANT!



Note the following important points when using red-eye reduction.

- Red-eye reduction does not work unless the people in the image are looking directly at the camera (flash). Before pressing the shutter release button, call out to the subjects so they all look at the camera.
- Red-eye reduction may not work very well if the subjects are located far away from the camera.

### Flash Precautions

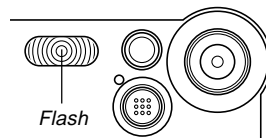
- Take care that your fingers do not block the flash when you hold the camera. Covering the flash with your finger can greatly reduce its effectiveness.



- The approximate effective range of the flash is shown below. The flash is unable to adequately illuminate a subject that is outside this range.  
1 meter to 2 meters
- The flash takes anywhere from a few seconds as long as 10 seconds to attain full charge after being fired. The actual time required depends on the battery level, temperature, and other conditions.
- The flash does not fire during movie recording. This is indicated by  on the monitor screen.
- The flash unit may not be able to charge when battery power is low. Low battery power is indicated by the  on the monitor screen, and when the flash fails to fire properly resulting in poor image exposure. When these symptoms occur, charge the camera's battery as soon as possible.

## BASIC IMAGE RECORDING

- When the red-eye reduction mode (👁) is being used, flash intensity is adjusted automatically in accordance with the exposure. The flash may not fire at all when the subject is brightly lit.
- White balance is fixed while the flash is being used, so sunlight, fluorescent lighting, or other sources of illumination in the immediate area may affect the coloring of the recorded image.

### Using the Self-timer

The self-timer delays shutter release so it is performed about 10 seconds after you press the shutter release button.

- 1. In the REC mode, press MENU.**
- 2. Rock the controller left or right to select the “REC” tab.**
- 3. Rock the controller up or down to select “Self-timer”, and then rock the controller to the right.**
- 4. Rock the controller up or down to select “10 sec”, and then click.**
  - Selecting “Off” in step 4 disables the self-timer.

### 5. Record the image.

- The self-timer lamp flashes and the shutter releases about 10 seconds after you press the shutter release button.
- You can interrupt an ongoing self-timer countdown by pressing the shutter release button while the self-timer lamp is flashing.
- The self-timer turns off automatically after the shutter releases.

Self-timer lamp

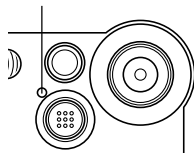

### Specifying Image Size and Quality

You can specify the image size and image quality to suit the type of image you are recording.

#### To specify the image size

1. In the REC mode, press MENU.
2. Rock the controller left or right to select the “REC” tab.
3. Rock the controller up or down to select “Size”, and then rock the controller to the right.
4. Rock the controller up or down to select the setting you want, and then click.

1600 x 1200 : 1600 x 1200 pixels

1280 x 960 : 1280 x 960 pixels

640 x 480 : 640 x 480 pixels

#### NOTE

- Use 1600 x 1200 when you plan to produce a large print of the image. Use 640 x 480 when you need to economize on space because you plan to send images in e-mail, etc.



## To specify the image quality



1. In the REC mode, press MENU.
2. Rock the controller left or right to select the “REC” tab.
3. Rock the controller up or down to select “Quality”, and then rock the controller to the right.
4. Rock the controller up or down to select the setting you want, and then click.

# OTHER RECORDING FUNCTIONS

This chapter describes the other powerful features and functions that are available for recording.

## Exposure Compensation (EV Shift)

Exposure compensation lets you change the exposure setting (EV value) manually to adjust for the lighting of your subject. This feature helps to achieve better results when recording a backlit subject, a strongly lit subject indoors, and a subject that is against a dark background.

Exposure Compensation Range:  $-2.0\text{EV}$  to  $+2.0\text{EV}$   
Steps:  $1/3\text{EV}$

**1. In the REC mode, press MENU.**

**2. Select the “REC” tab, select “EV Shift”, and then rock the controller to the right.**

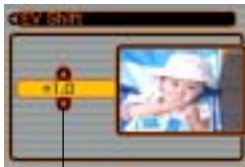

*Exposure compensation value*

**3. Rock the controller up or down to change the exposure compensation value, and then click.**

- Clicking the controller registers the displayed value.

Up : Increases the EV value. A higher EV value is best used for light-colored subjects and backlight subjects.

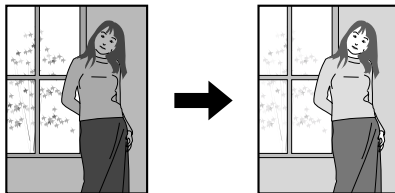

Down : Decreases the EV value. A lower EV value is best for dark-color subjects and for shooting outdoors on a clear day.

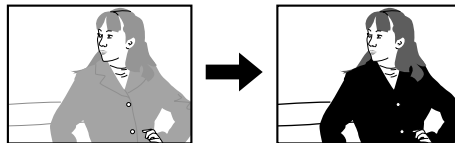

- To cancel exposure compensation, adjust the value until it becomes 0.0.

### 4. Record the image.

#### ▶▶ IMPORTANT! ◀◀

- When shooting under very dark or very bright conditions, you may not be able to obtain satisfactory results even after performing exposure compensation.

#### ▶▶ NOTES ◀◀

- Performing an EV shift operation causes the metering mode to switch automatically to center weighted metering. Returning the EV shift value to 0.0 causes the metering mode to change back to multi-pattern metering.
- You can use the key customization feature (page 52) to configure the camera so the exposure compensation value changes whenever you rock the controller left or right while in the REC mode.





### Adjusting the White Balance

The wavelengths of the light produced by various light sources (sunlight, light bulb, etc.) can affect the color of a subject when it is recorded. White balance lets you make adjustments to compensate for different lighting types, to make the colors of an image appear more natural.

1. In the REC mode, press MENU.
2. Select the “REC” tab, select “White Balance”, and then rock the controller to the right.



### 3. Rock the controller up or down to select the setting you want, and then click.

When shooting under these conditions:	Select this setting:
Normal conditions	Auto
Outdoor daylight	
Shade	
Incandescent light bulb (reddish tinge)	
Fluorescent light (greenish tinge)	
Difficult lighting that requires manual control (This page)	Manual

#### »» NOTES ««

- Selecting “Manual” changes white balance to the settings achieved the last time a manual white balance operation was performed.
- You can use the key customization feature (page 52) to configure the camera so the white balance setting changes whenever you rock the controller left or right while in the REC mode.

## Adjusting White Balance Manually

Under some light sources, automatic white balance under the “Auto” setting can take a long time to complete. Also, the auto white balance range (color temperature range) is limited. Manual white balance helps to ensure that colors are recorded correctly for a particular light source. Note that you must perform manual white balance under the same conditions you will be shooting under. You must also have a white piece of paper or other similar object on hand in order to perform manual white balance.

### 1. In step 3 of the procedure under “Adjusting the White Balance”, select “Manual”.

- This causes the object you last used to adjust manual white balance to appear on the monitor screen.



**2. Point the camera at a white piece of paper or similar object under the lighting conditions for which you want to set the white balance, and then press the shutter release button.**

- This adjusts the white balance.

**3. Click the controller.**

- This registers the white balance settings and returns to the REC mode.
- Dim lighting or pointing the camera at a dark colored object can cause white balance to take a long time to complete.

### Using the Best Shot Mode

Selecting one of the six Best Shot scenes automatically sets up the camera for recording a similar type of image.

**1. In the REC mode, press MENU.**

**2. Select the “REC” tab, select “REC Mode”, and then rock the controller to the right.**



**3. Rock the controller up or down to select **BS** (Best Shot), and then click.**

- This enters the Best Shot Mode and causes the **BS** icon to appear on the monitor screen.
- Pressing the shutter release button at this point records the image using the camera setup of scene that was selected when you last exited the Best Shot Mode, and completes this procedure. If you want to select a different Best Shot scene, proceed with step 4.

### 4. Click the controller.

- This displays a sample scene.

### 5. Rock the controller left or right to select the sample scene you want, and then click.

### 6. Record the image.

#### ▶▶ IMPORTANT! ◀◀

- Best Shot scenes were not recorded using this camera. They are provided as samples only.
- Images recorded using a Best Shot scene may not produce the results you expected due to shooting conditions and other factors.
- After clicking the controller in step 5 to select a sample scene, you can change to another scene by clicking the controller again, rocking the controller left or right to select another sample scene, and then clicking.

## Using the Movie Mode

You can record movies up to 30 seconds long. The EX-M2 even lets you record audio along with your movies.

- File Format: AVI  
AVI format conforms to the Motion JPEG format promoted by the Open DML Group.
- Image Size: 320 x 240 pixels
- Movie File Size: Approximately 150KB/second.
- Maximum Movie Length
  - One Movie: 30 seconds
  - Total Movie Time:  
80 seconds with built-in memory; 410 seconds with 64MB SD memory card

**1. In the REC mode, press MENU.**

**2. Select the “REC” tab, select “REC Mode”, and then rock the controller to the right.**

## OTHER RECORDING FUNCTIONS

### 3. Rock the controller up or down to select (Movie), and then click.

- “Remaining capacity” shows how many 30-second movies can still be recorded to memory.

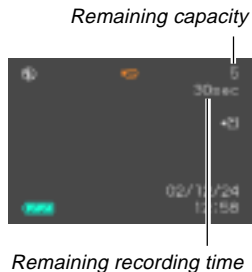

Remaining recording time

### 4. Point the camera at the subject and then press the shutter release button.

- Movie recording continues for 30 seconds, or until you stop it by pressing the shutter release button again.
- The remaining recording time value counts down on the monitor screen as you record.

### 5. After movie recording is stopped, press the shutter release button one more time to store the movie file.

- This causes the movie file to be stored into camera memory.
- To cancel storage of the movie file, rock the controller down to select “Delete” while file storage is being performed, and then click.

### IMPORTANT!

- The flash does not fire in the Movie Mode.
- The EX-M2 also records audio. Note the following points when recording a movie with the EX-M2.
  - Take care that you do not block the microphone with your fingers.
  - Good recording results are not possible when the camera is too far from the subject.
  - Operating camera buttons during recording can cause button noise to be included in the audio.
  - Movie audio is recorded in monaural.

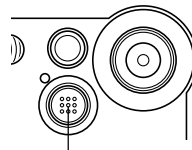

Microphone

## Recording Audio (EX-M2 Only)

### Adding Audio to a Snapshot

You can add audio to a snapshot after you record it.

- **Image Format: JPEG**  
JPEG is an image format that provides efficient data compression. The file extension of a JPEG file is “.JPG”.
- **Audio Format: WAVE/ADPCM recording format**  
This is the Windows standard format for audio recording. The file extension of a WAVE/ADPCM file is “.WAV”.
- **Recording Time:**  
Up to about 30 seconds per image
- **Audio File Size:**  
Approximately 120KB (30-second recording of approximately 4KB per second)

1. In the REC mode, press MENU.
2. Select the “REC” tab, select “REC Mode”, and then rock the controller to the right.
3. Rock the controller up or down to select  (Snapshot Audio), and then click.
  - This enters the Snapshot Audio Mode.
4. Press the shutter release button to record the image.
  - After the image is recorded, the camera enters audio recording standby, with the image you just recorded on the monitor screen.
  - You can cancel audio recording standby by pressing MENU.



*Remaining recording time*



## 5. Press the shutter release button to start audio recording.

- The operation/flash charge lamp flashes green as recording is performed.
- Even if you have the monitor screen turned off (page 51), the monitor screen turns on while you are adding audio to a snapshot.

## 6. Recording stops after about 30 seconds or when you press the shutter release button.

## Recording Your Voice

The Voice Recording Mode provides quick and easy recording of your voice.

- **Audio Format:** WAVE/ADPCM recording format  
This is the Windows standard format for audio recording. The file extension of a WAVE/ADPCM file is “.WAV”.
- **Recording Time:**  
Approximately 50 minutes with built-in memory
- **Audio File Size:**  
Approximately 120KB (30-second recording of approximately 4KB per second)

### 1. In the REC mode, press MENU.

### 2. Select the “REC” tab, select “REC Mode”, and then rock the controller to the right.

### 3. Rock the controller up or down to select (Voice Recording), and then click.

- This enters the Voice Recording Mode.



*Remaining recording time*

### 4. Press the shutter release button to start voice recording.

- The remaining recording time value counts down on the monitor screen and the operation/flash charge lamp flashes green as recording is performed.
- Clicking the controller during voice recording turns off the monitor screen. The monitor screen turns back on automatically when recording is complete.

### 5. Recording stops when you press the shutter release button, when memory becomes full, or when the battery goes dead.

### ■ Audio Recording Precautions

- Keep the microphone on the front of the camera pointed at the subject.
- Take care that you do not block the microphone with your fingers.

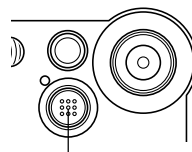

*Microphone*

- Good recording results are not possible when the camera is too far from the subject.
- Operating camera buttons during recording can cause button noise to be included in the audio.
- Pressing the power button or changing the mode selector setting stops recording at that point and stores any audio recorded up to that point.
- You can also perform “after-recording” to add audio to a snapshot after recording it, and also change the audio recorded for an image. See page 59 for more information.

**REC Mode Camera Settings****Turning the Monitor Screen On and Off**

Turning off the monitor screen when recording helps to conserve battery power.

- 1. In the REC mode, press MENU.**
- 2. Select the “REC” tab, select “Indicators”, and then rock the controller to the right.**
- 3. Rock the controller up or down to select the setting you want, and then click.**

To do this:	Select this setting:
Turn off the monitor screen	LCD-OFF
Turn on the monitor screen	LCD-ON

**▶▶ IMPORTANT! ◀◀**

- The monitor screen turns back on automatically in the following cases, even if “LCD-OFF” is selected with the above procedure.
  - When you press MENU (Monitor screen remains on for about one minute.)
  - When you rock the controller left or right
  - When you enter the Movie Mode or Voice Recording Mode for recording
  - When you use the Snapshot Audio Mode to add audio to a snapshot

**Turning Image Review On and Off**

Image review displays an image on the monitor screen as soon as you record it. Use the following procedure to turn image review on and off.

- 1. In the REC mode, press MENU.**
- 2. Select the “REC” tab, select “Review”, and then rock the controller to the right.**

## OTHER RECORDING FUNCTIONS

3. Rock the controller up or down to select the setting you want, and then click.

To do this:	Select this setting:
Display images on the monitor screen for about a half second immediately after they are recorded	On
Do not display images immediately after they are recorded	Off

### Assigning Functions to the Controller

A “key customization” feature lets you assign a setting function to the controller. After you assign a function, the corresponding parameter is changed whenever you rock the controller left or right in the REC mode.

1. In the REC mode, press MENU.
2. Select the “REC” tab, select “L/R Key”, and then rock the controller to the right.

3. Rock the controller up or down to select the setting you want, and then click.

When you want to assign this function to the controller :	Select this:
Recording mode <ul style="list-style-type: none"><li>• Rock left or right to cycle through modes.</li><li>• EX-S2: Snapshot, Best Shot, Movie</li><li>• EX-M2: Snapshot, Best Shot, Movie, Snapshot Audio, Voice Recording (page 106)</li></ul>	REC Mode
Exposure compensation <ul style="list-style-type: none"><li>• Rock left to decrease, rock right to increase (page 42)</li></ul>	EV Shift
Flash mode <ul style="list-style-type: none"><li>• Rock left or right to cycle through modes (page 37).</li></ul>	Flash
White balance mode <ul style="list-style-type: none"><li>• Rock left or right to cycle through modes (page 43).</li></ul>	White Balance
No function assigned	Off

#### NOTE

- The initial default setting is “REC Mode”.

## Specifying Power On Default Settings

The camera's "mode memory" feature lets you specify the power on default settings individually for the recording mode, flash mode, digital zoom mode, and white balance mode. Turning on mode memory for a mode tells the camera to remember the status of that mode when you turn off the camera, and restore it the next time you turn the camera back on. When mode memory is turned off, the camera automatically restores the initial factory default setting for the applicable mode.

The following table shows what happens when you turn mode memory on or off for each mode.

Mode	Mode Memory On	Mode Memory Off (Factory Default)
Recording Mode	<ul style="list-style-type: none"> <li>Remembers the current status when the camera is turned off, and restores it when the camera is turned back on again.</li> </ul>	Snapshot
Flash Mode		Auto
Digital Zoom Mode		On
White Balance Mode		Auto

1. In the REC mode, press MENU.
2. Select the "Memory" tab, select the item you want to change, and then rock the controller to the right.
3. Rock the controller up or down to select the setting you want, and then click.

To do this:	Select this setting:
Turn on mode memory so settings are restored at power on	On
Turn off mode memory so settings are initialized at power on	Off

# PLAYBACK

You can use the camera's built in monitor screen to play back files.

## Basic Playback Operation

Use the following procedure to scroll through files stored in the camera's memory.

### 1. Press the power button to turn on the camera.

- This causes an image or a message to appear on the monitor screen.

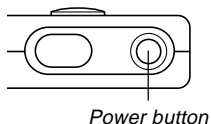

### 2. Align the mode selector with "PLAY".

- This enters the PLAY mode.

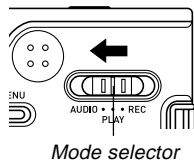

### 3. Rock the controller right (forward) or left (back) to scroll through files on the monitor screen.



### NOTES

- Holding the controller to the left or right scrolls at high speed.
- Note that the images produced on the monitor screen of this camera are simplified versions of the actual image stored in memory.

## Playing an Audio Snapshot (EX-M2 Only)

Perform the steps below to display an audio snapshot (indicated by a  indicator) and play its audio.

**1. In the PLAY mode, rock the controller left or right until the image you want is displayed.**

**2. Click the controller.**

- This plays back the audio that accompanies the displayed image.
- You can perform the following operations while audio is playing.



To do this:	Do this:
Fast forward or fast reverse the audio	Hold the controller left or right.
Pause and unpauses audio playback	Click the controller.
Adjust audio volume	Rock the controller up or down.
Cancel playback	Press MENU.

### ▶▶ IMPORTANT! ◀◀

- Audio volume can be adjusted only when playback is being performed or is paused.
- When you have the LCD remote controller connected to the camera, audio is output through the stereo headphones (page 97) instead of the camera's speaker. Output through the headphones is monaural.
- The volume of audio recorded with the camera cannot be adjusted using the LCD remote controller. Use the camera's controller to adjust volume level in this case.

### Zooming the Displayed Image

Perform the following procedure to zoom the image currently on the monitor screen up to four times its normal size.

1. In the PLAY mode, rock the controller left or right until the image you want is displayed.
2. Press MENU.
3. Select the "PLAY" tab, select "Zoom", and then rock the controller to the right.
4. Rock the controller up to enlarge the image, or down to reduce its size.



5. After clicking the controller, you can then rock it up, down, left, or right to scroll to different parts of the zoomed image.



- After clicking again, you can rock the controller up or down to zoom in and out on the image again.
6. Press MENU to return the image to its original size.

#### ►► IMPORTANT! ◀◀

- You cannot enlarge a movie image.



## Resizing an Image

You can use the following procedure to change a snapshot image to either VGA size (640 x 480 pixels) or QVGA size (320 x 240 pixels).

- VGA size and QVGA size are the optimum image sizes for attachment to e-mail messages or incorporation into Web pages.

**1. In the PLAY mode, press MENU.**

**2. Select the “PLAY” tab, select “Resize”, and then rock the controller to the right.**



**3. Rock the controller left or right to scroll through images and display the one you want to resize.**

**4. Rock the controller up or down to select the setting you want, and then click.**

To do this:	Select this:
Resize to 640 x 480 pixels (VGA)	640 x 480
Resize to 320 x 240 pixels (QVGA)	320 x 240
Cancel the resizing operation	Cancel

### ►► IMPORTANT! ◀◀

- Resizing an image causes a new (resized) version to be stored as a separate file.
- Images smaller than 320 x 240 pixels cannot be resized.
- Note that you can resize snapshots recorded with this camera only.
- If the message “The function is not supported for this file”. appears, it means that the current image cannot be resized.
- The resize operation cannot be performed if there is not enough memory to store the resized image.

## Playing a Movie

Use the following procedure to play back a movie recorded in the movie mode.

1. In the **PLAY** mode, rock the controller left or right until the movie you want to play is displayed.



2. Click the controller.

- This start playback of the movie.

- You can perform the following operations while a movie is playing.

To do this:	Do this:
Fast forward or fast reverse the movie	Hold the controller left or right.
Pause and unpause movie playback	Click the controller.
Skip forward or back one frame while paused	Rock the controller left or right.
Cancel playback	Press MENU.
Adjust audio volume (EX-M2 only)	Rock the controller up or down.

### ►► IMPORTANT! ◀◀

- A movie plays until the end and then stops. You cannot repeat-play a movie.
- Audio volume can be adjusted only when playback is being performed or is paused.
- When you have the LCD remote controller connected to the camera, audio is output through the stereo headphones (page 97) instead of the camera's speaker. Output through the headphones is monaural.
- The volume of audio recorded with the camera cannot be adjusted using the LCD remote controller. Use the camera's controller to adjust volume level in this case.

### Adding Audio to a Snapshot (EX-M2 Only)

The “after-recording” feature lets you add audio to snapshots after they are recorded. You can also re-record an audio image (one with a  icon on it).

- **Audio Format:** WAVE/ADPCM recording format  
This is the Windows standard format for audio recording. The file extension of a WAVE/ADPCM file is “.WAV”.
- **Recording Time:**  
Up to about 30 seconds per image
- **Audio File Size:**  
Approximately 120KB (30-second recording of approximately 4KB per second)

**1. In the PLAY mode, rock the controller left or right to scroll through snapshots until the one to which you want to add audio is displayed.**

**2. Press MENU.**

**3. Select the “PLAY” tab, select “Dubbing”, and then rock the controller to the right.**



**4. Press the shutter release button to start audio recording.**

**5. Recording stops after about 30 seconds or when you press the shutter release button.**

## To re-record audio

1. In the PLAY mode, rock the controller left or right to scroll through snapshots until the one whose audio you want to re-record is displayed.
2. Select the “PLAY” tab, select “Dubbing”, and then rock the controller to the right.
3. Rock the controller up or down to select “Delete”, and then click.
  - If you merely want to delete the audio with re-recording, press MENU here to complete the procedure.
4. Press the shutter release button to start audio recording.
5. Recording stops after about 30 seconds or when you press the shutter release button.
  - This deletes the previous recording and replaces it with a new one.

### ▶▶ IMPORTANT! ◀◀

- Keep the microphone on the front of the camera pointed at the subject.
- Take care that you do not block the microphone with your fingers.

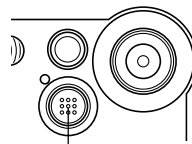

*Microphone*

- Good recording results are not possible when the camera is too far from the subject
- Operating camera buttons during recording can cause button noise to be included in the audio.
- The  (Audio) icon appears on the monitor screen after audio recording is complete.
- You will not be able to record audio when remaining memory capacity is low.
- The following types of audio recording are not supported.
  - Adding audio to a movie image
  - Adding audio to a protected snapshot (page 65)
- Audio that is re-recorded or deleted cannot be recovered. Make sure you no longer need audio before re-recording or deleting it.

## Playing Back a Voice Recording File (EX-M2 Only)

Perform the following steps to play back a voice recording file.

**1. In the PLAY mode, rock the controller left or right to display the voice file (a file with  on it) you want to play.**

**2. Click the controller.**

- This starts playback of the voice recording file through the camera's speaker.
- You can perform the following operations while audio is playing.



To do this:	Do this:
Fast forward or fast reverse the audio	Hold the controller left or right.
Pause and unpause audio playback	Click the controller.
Adjust audio volume	Rock the controller up or down.
Cancel playback	Press MENU.

### ▶▶ IMPORTANT! ◀◀

- Audio volume can be adjusted only when playback is being performed or is paused.
- When you have the LCD remote controller connected to the camera, audio is output through the stereo headphones (page 97) instead of the camera's speaker. Output through the headphones is monaural.
- The volume of audio recorded with the camera cannot be adjusted using the LCD remote controller. Use the camera's controller to adjust volume level in this case.

# DELETING FILES

You can delete a single file, or you can delete all files currently in memory.

## ▶▶ IMPORTANT! ◀◀

- Note that file deletion cannot be undone. Once you delete a file, it is gone. Make sure you really do not need a file anymore before you delete it. Especially when deleting all files, make sure you check all the files you have stored before proceeding.
- Delete cannot be performed when all the files in memory are protected (page 65).
- A protected file cannot be deleted. To delete a protected file, unprotect it first (page 65).
- On the EX-M2, deleting an audio snapshot deletes both the image file and the audio file attached to it.

## Deleting a Single File

Perform the following steps when you want to delete a single file.

1. In the **PLAY** mode, **rock the controller down** .



2. **Rock the controller left or right to scroll through files and display the one you want to delete.**
3. **Rock the controller up or down to select "Delete".**
  - To exit the file delete operation without deleting anything, select "Cancel".
4. **Click the controller to delete the file.**
  - Repeat steps 2 through 4 to delete other files, if you want.
5. **Press MENU to exit the menu screen.**

### ▶▶ IMPORTANT! ◀◀

- If a file cannot be deleted for some reason, the message “The function is not supported for this file.” appears when you try to delete it.

### Deleting All Files

The following procedure deletes all unprotected files currently in memory.

- 1. In the PLAY mode, rock the controller down .**
- 2. Rock the controller up or down to select “All File Delete”, and then click.**
- 3. Rock the controller up or down to select “Yes”.**
  - To exit the file delete operation without deleting anything, select “No”.
- 4. Click the controller to delete all the files.**

# FILE MANAGEMENT

The file management capabilities of the camera make it easy to keep track of images. You can protect files against deletion, and even use its DPOF feature to specify images for printing.

## Folders

Your camera automatically creates a directory of folders in its built-in flash memory or on the memory card to store images.

## Memory Folders and Files

An image you record is automatically stored in a folder, whose name is a serial number. You can have up to 900 folders in memory at the same time. Folder names are generated as shown below.

Example: Name of the 100th folder.

100CASIO

|  
*Serial number (3 digits)*

Each folder can hold files numbered up to 9,999.

Trying to store the 10,000th file in a folder causes the next serially numbered folder to be created. Folder names are generated as shown below.

Example: Name of the 26th file

CIMG0026.JPG

|                   |  
*Extension*

|  
*Serial number (4 digits)*

- The actual number of files you will be able to store on a memory card depends on the image quality settings, capacity of the card, etc.
- For details about the directory structure, see “Memory Directory Structure” on page 94.





## Protecting Files

Once you protect a file it cannot be deleted (page 62). You can protect files individually or you can protect all files in memory with a single operation.

### To protect a single file

1. In the **PLAY** mode, press **MENU**.
2. Select the “**PLAY**” tab, select “**Protect**”, and then rock the controller to the right.
 
3. Rock the controller left or right to scroll through files and display the one you want to protect.

4. Rock the controller up or down to select “**On**”, and then click.
 

- A file that is protected is indicated by the  mark.
- To unprotect a file, select “**Off**” in step 4, and then click.

5. Press **MENU** to exit the menu screen.

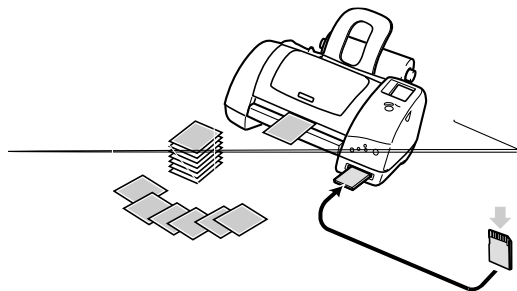

## To insert the date during printing

### »» NOTE ««

- To insert the date during printing, you need to use the following procedure to turn on the date insertion feature before configuring other print settings.

1. In the **PLAY** mode, rock the controller up (DPOF).
2. Rock the controller up or down to select “Date”, and then rock the controller to the right.
3. Rock the controller up or down to select “On”, and then click.
  - If you do not want the date inserted, select “Off”.

## To configure print settings for a single image

1. In the **PLAY** mode, rock the controller up (DPOF).



2. Rock the controller up or down to select “Select images”, and then rock the controller to the right.



3. Rock the controller left or right to scroll through images and display the one you want to print.

**4. Rock the controller up or down to specify the number of copies.**

- You can specify up to 99 for the number of copies. Specify 00 if you do not want to have the image printed.
- Repeat steps 3 through 4 to configure settings for other images, if you want.

**5. Click the controller to complete the procedure.****To configure print settings for all images****1. In the PLAY mode, rock the controller up (DPOF).****2. Rock the controller up or down to select “All images”, and then rock the controller to the right.****3. Rock the controller up or down to specify the number of copies.**

- You can specify up to 99 for the number of copies. Specify 00 if you do not want to have the image printed.

**4. Click the controller to complete the procedure.**

### PRINT Image Matching II

Images include PRINT Image Matching II data (mode setting and other camera setup information). A printer that supports PRINT Image Matching II reads this data and adjusts the printed image accordingly, so your images come out just the way you intended when you recorded them.

\* SEIKO EPSON Corporation holds the copyright for PRINT Image Matching and PRINT Image Matching II.



### Exif Print

Exif Print is an internationally supported, open standard file format that makes it possible to capture and display vibrant digital images with accurate colors. With Exif 2.2, files include a wide range of shooting condition information that can be interpreted by an Exif Print printer to produce better-looking prints.



#### »» IMPORTANT! ««

- Information about the availability of Exif Print compatible printer models can be obtained from each printer manufacturer.

## Using the FAVORITE Folder

You can copy snapshots from a file storage folder (page 94) to the FAVORITE folder in built-in memory (page 94). This makes it easy to keep track of important files.

### To copy a file to the FAVORITE folder

1. In the PLAY mode, press MENU.

2. Select the “PLAY” tab, select “Favorites”, and then rock the controller to the right.



3. Rock the controller up or down to select “Save”, and then click.

- This displays the names of the files in built-in memory or on the loaded memory card.



4. Rock the controller left or right to select the file you want to copy to the FAVORITE folder.

5. Rock the controller up or down to select “Save”, and then click.

- This copies the displayed file to the FAVORITE folder.

### NOTES

- Copying an image file with the above procedure creates a 320 x 240-pixel QVGA-size image in the FAVORITE folder.
- A file copied into the FAVORITE folder is automatically assigned a file name that is a serial number (0001 to 9999).

## To display a file in the FAVORITE folder

1. In the PLAY mode, press MENU.
2. Select the “PLAY” tab, select “Favorites”, and then rock the controller to the right.
3. Rock the controller up or down to select “Show”, and then click.
  - If the FAVORITE folder is empty, the message “No Favorites file!” appears.
4. Rock the controller right (forward) or left (back) to scroll through the files in the FAVORITE folder.



### ►► NOTE ◀◀

- Holding the controller to the left or right scrolls at high speed.

## To delete a file from the FAVORITE folder

1. In the PLAY mode, press MENU.
2. Select the “PLAY” tab, select “Favorites”, and then rock the controller to the right.
3. Rock the controller up or down to select “Delete”, and then click.
4. Rock the controller left or right to select the file you want to delete from the FAVORITE folder.
5. Rock the controller up or down to select “Delete”, and then click.
  - This deletes the file from the FAVORITE folder

### ►► IMPORTANT! ◀◀

- You cannot use the delete operations on page 62 to delete images from the FAVORITE folder. Performing the memory format operation (page 75), however, does delete FAVORITE folder files.

# OTHER SETTINGS

## Turning the Key Tone On and Off

Use the following procedure to turn the tone that sounds when you press a key on and off.

- 1. In the REC mode or PLAY mode, press MENU.**
- 2. Select the “Set Up” tab, select “Beep”, and then rock the controller to the right.**
- 3. Rock the controller up or down to select the setting you want, and then click.**

To do this:	Select this:
Turn on the key tone	On
Turn off the key tone	Off

## Specifying an Image for the Startup Screen

You can specify an image you recorded with the camera as the startup screen image, which causes it to appear on the monitor screen for about two seconds whenever you turn on the camera.

- 1. Enter the REC mode or the PLAY mode.**
- 2. Press MENU.**
- 3. Select the “Set Up” tab, select “Startup”, and then rock the controller to the right.**
- 4. Rock the controller left or right to display the image you want to use as the startup image.**
- 5. Rock the controller up or down to select the setting you want, and then click.**

To do this:	Select this:
Use the currently displayed image as the startup screen image	On
Disable the startup screen	Off



### ▶▶ IMPORTANT! ◀◀

- You can select any one of the following types of image as the startup image.
  - The camera's built-in startup image
  - A snapshot you recorded with the camera
  - A movie you recorded with the camera two seconds or less in length and 200KB or less in size
- The snapshot image or movie that you select as the startup image is stored in a special memory location called "startup image memory." Only one image can be stored in startup image memory. Selecting a new startup image overwrites anything that is already stored in startup image memory. Except for the camera's built-in startup image, if you want to return to a previous startup image, you need to have a separate copy of that image in the camera's standard image storage memory.

### Changing the Date and Time Setting

Use the following procedure to change the date and time setting.

- 1. In the REC mode or PLAY mode, press MENU.**
- 2. Select the "Set Up" tab, select "Adjust", and then rock the controller to the right.**
- 3. Set the date and the time.**

To do this:	Do this:
Change the setting at the current cursor location	Rock the controller up or down.
Move the cursor between settings	Rock the controller left or right.

- 4. Click to register the settings and exit the setting screen.**

## Changing the Date Format

You can select from among three different formats for display of the date.

1. In the REC mode or PLAY mode, press MENU.
2. Select the “Set Up” tab, select “Date Style”, and then rock the controller to the right.
3. Rock the controller up or down to select the setting you want, and then click.

Example: October 23, 2002

To display the date like this:	Select this format:
02/10/23	YY/MM/DD
23/10/02	DD/MM/YY
10/23/02	MM/DD/YY

## Changing the Display Language

You can use the following procedure to select one of six languages as the display language.

1. In the REC mode or PLAY mode, press MENU.
2. Select the “Set Up” tab, select “Language”, and then rock the controller to the right.
3. Rock the controller up or down to select the option you want, and then click.

日本語 : Japanese

English : English

Français : French

Deutsch : German

Español : Spanish

Italiano : Italian

### Formatting Built-in Memory

Formatting built-in memory deletes any data stored in it.

#### ►► IMPORTANT! ◀◀

- Note that data deleted by a format operation cannot be recovered. Check to make sure you do not need any of the data in memory before you format it.
- Formatting memory deletes all files in memory, even files that are protected (page 65).

#### **1. Check to make sure there is no memory card loaded in the camera.**

- If there is a memory card loaded in the camera, remove it (page 77).

#### **2. In the REC mode or PLAY mode, press MENU.**

#### **3. Select the “Set Up” tab, select “Format”, and then rock the controller to the right.**

#### **4. Rock the controller up or down to select “Format”, and then click.**

- To exit the format operation without formatting, select “Cancel”.

# USING A MEMORY CARD

You can expand the storage capabilities of your camera by using a commercially available memory card (SD memory card or MultiMedia Card). You can also copy files from built-in flash memory to a memory card and from a memory card to flash memory.

- Normally, files are stored in built-in flash memory. When you insert a memory card, however, the camera automatically stores files to the card.
- Note that you cannot save files to built-in memory while a memory card is installed in the camera.

## ▶▶ IMPORTANT! ◀◀

- Make sure you turn off the camera before inserting or removing a memory card.
- Be sure to orient the card correctly when inserting it. Never try to force a memory card into the slot when you feel resistance.
- See the instructions that come with the memory card for information about how to use it.
- Certain types of cards can slow down processing speeds.
- SD memory cards have a write protect switch, which you can use to protect against accidental deletion of image data. Note, however, if you write protect an SD memory card, you must remove write protection whenever you want to record to it, format it, or delete any of its files.

## Using a Memory Card

### To insert a memory card into the camera

1. Making sure that the contacts of the memory card are facing towards the top of the camera, carefully insert the card into the slot as far as it will go.

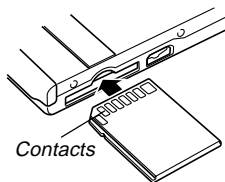

### To remove a memory card from the camera

1. Press the memory card into the camera and then release it. This will cause the card to come part way out of the camera.
2. Pull the memory card out of the slot.

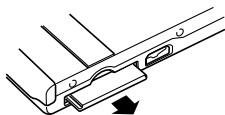
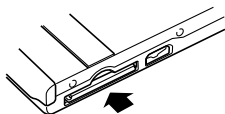

### IMPORTANT!

- Never insert any other object besides a memory card into the camera's card slot. Doing so creates the risk of damage to the camera and card.
- If you are not using a memory card, be sure to insert the dummy card into this slot to protect against dust and damage.
- The dummy card is intended for use with this camera only. Never insert it into the card slot of any other type of device.
- Should water or any foreign object ever get into the card slot, immediately turn off the camera, remove the battery, and contact your dealer or nearest CASIO authorized service center.
- Never remove a card from the camera while the operation/flash charge lamp is flashing. Doing so can cause the files save operation to fail, and even damage the memory card.

### Formatting a Memory Card

Formatting a memory card deletes any data already stored on it.

#### ▶▶ IMPORTANT! ◀◀

- Be sure to use the camera to format a memory card. Formatting a memory card on a computer and then using it in the camera can slow down data processing by the camera. In the case of an SD card, formatting on a computer can result in non-conformity with the SD format, causing problems with compatibility, operation, etc.
- Note that data deleted by a memory card format operation cannot be recovered. Check to make sure you do not need any of the data on the memory card before you format it.
- Formatting a memory card that contains files deletes all the files, even those that are protected (page 65).

- 1. Load the memory card into the camera.**
- 2. Turn on the camera. Next, enter the REC mode or PLAY mode and press MENU.**
- 3. Select the “Set Up” tab, select “Format”, and then rock the controller to the right.**
- 4. Rock the controller up or down to select “Format”, and then click.**
  - To exit the format operation without formatting, select “Cancel”.

### Memory Card Precautions

- Use only an SD memory card or a MultiMediaCard with this camera. Proper operation is not guaranteed when any other type of card is used.
- Electrostatic charge, electrical noise, and other phenomena can cause data to become corrupted or even lost. Always make sure that you always back up important data on other media (MO disc, computer hard disk, etc.)
- If a memory card starts to behave abnormally, you can restore normal operation by reformatting it. However, we recommend that you always take along more than one memory card whenever using the camera far away from the home or office.
- We recommend that you format a memory card before using it for the first time after purchasing it, or whenever the card you are using seems to be the cause of abnormal images.
- Before starting a format operation, check to make sure that the battery is fully charged. Power interruption during the format operation can result in improper formatting, and even damage the memory card and make it unusable.

### Copying Files

Use the procedures below to copy files between built-in memory and a memory card.

#### To copy all the files in built-in memory to a memory card

1. Load the memory card into the camera.
2. Turn on the camera. Next, enter the PLAY mode and press MENU.
3. Select the “PLAY” tab, select “Copy”, and then rock the controller to the right.



### **4. Rock the controller up or down to select “Built-in → Card”, and then click.**

- This starts the copy operation and displays the message “Busy... Please wait...”
- After the copy operation is complete, the monitor screen shows the last file in the folder.

### **To copy a file from a memory card to built-in memory**

- 1. Perform steps 1 through 3 of the procedure under “To copy all the files in built-in memory to a memory card.”**
- 2. Rock the controller up or down to select “Card → Built-in”, and then click.**
- 3. Rock the controller left or right to select the file you want to copy.**
- 4. Rock the controller up or down to select “Copy”, and then click.**
  - This starts the copy operation and displays the message “Busy... Please wait...”
  - The file reappears on the monitor screen after the copy operation is complete.



# USING THE CAMERA WITH A COMPUTER

The USB cradle that comes with your camera makes it easy to connect to a computer that is equipped with a USB port. You can also transfer files using the memory card, if your computer is equipped to read memory cards.

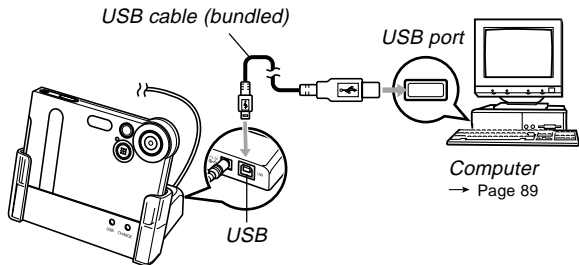

## Installing the Software from the CD-ROM

Before you can exchange files with your computer, you first need to install the software contained on the CD-ROM that comes with the camera.

## About the bundled CD-ROM

The CD-ROM that comes bundled with the camera contains the following software.

### Photo Loader (for Windows/Macintosh)

This application loads image data saved in JPEG and AVI format from a digital camera onto your computer.

### Photohands (for Windows)

This application is for retouching and printing image files.

### USB Driver for Mass Storage (for Windows/Macintosh)

This is the software that makes it possible for the camera to “talk” to your personal computer over a USB connection. If you are using Windows XP, Mac OS 9, or Mac OS X, do not install the USB driver from the CD-ROM. With these operating systems, you will be able to perform USB communication simply by connecting the camera to your computer with the USB cable.

### Internet Explorer (for Macintosh)

This is a browser application for reading HTML files. Images loaded by Photo Loader are stored in folders called “Libraries.” Internet Explorer displays the contents of a library on your computer screen.

### DirectX (for Windows)

This software provides an extended tool set including a codec that allows Windows 98 and 2000 to handle movie files recorded using a digital camera. You do not need to install DirectX if you are running Windows XP or Me.

### Acrobat Reader (for Windows/Macintosh)

This is an application that lets you read PDF files. Use it to read the user documentation for the camera, Photo Loader, and Photohands, all of which is included on the bundled CD-ROM.

### NOTE

- See the user documentation files (PDF) on the bundled CD-ROM for details about using Photo Loader and Photohands. See “Viewing User Documentation (PDF files)” on page 85 (Windows) and page 88 (Macintosh) of this manual for more information.

## Computer System Requirements

Computer system requirements depend on each of the applications, as described below.

### Windows

See the “Readme” file on the bundled CD-ROM.

### Macintosh

See the “readme” file on the bundled CD-ROM.

### Installing Software from the CD-ROM in Windows

Use the procedures in this section to install the software from the bundled CD-ROM to your computer.

#### NOTE

- You do not need to install software if you already have it installed on your computer.

The CD-ROM includes the software and user documentation for various languages. Check the CD-ROM menu screen to see if applications and user documentation are available for a particular language.

### Getting Started

Start up your computer and insert the CD-ROM into its CD-ROM drive. This will automatically launch the menu application, which displays a menu screen on your computer.



#### NOTE

- The menu application may not start up automatically on some computers. If this happens, navigate to the CD-ROM and double-click "menu.exe" to launch the menu application.

### Selecting a Language

First select a language. Note that some software is not available in all languages.

1. On the menu screen, click the language button in the upper left corner of the display.
2. On the list of languages that appears, select the one you want.

### Viewing the Contents of the “Read me” File

You should always read the “Read me” file for any application before installing it. The “Read me” file contains information you need to know when installing the application.

1. On the menu screen, click “Software.”
2. Click the name of the application you want to install.
3. Click the “Read me” button.

#### »» IMPORTANT! ««

- Before upgrading or reinstalling Photo Loader, or before installing it onto another computer, be sure to read the “Read me” file for information about retaining existing libraries.

### Installing an Application

1. On the menu screen, click “Software.”
2. Click the name of the application you want to install.
3. Click the “Install” button.
4. Follow the instructions that appear on your computer screen.

#### »» IMPORTANT! ««

- Be sure to follow the instructions carefully and completely. If you make a mistake when installing Photo Loader, you may not be able to browse your existing library information and HTML files that are created automatically by Photo Loader. In some cases, image files may be lost.
- When using an operating system other than Windows XP, never connect the camera to your computer without installing the USB driver from the CD-ROM first.

## Viewing User Documentation (PDF Files)

1. On the menu screen, click “Manual.”
2. Click the name of the application whose user documentation you want to read.
3. Click the “Read” button.

### ▶▶ IMPORTANT! ◀◀

- You need to have Adobe Acrobat Reader installed on your computer to read user documentation files. If you do not already have Adobe Acrobat Reader installed, you can install it from the bundled CD-ROM.

## Exiting the Menu Application

1. On the menu screen, click “Exit” to exit the menu.

## Installing Software from the CD-ROM on a Macintosh

The CD-ROM contains applications and user documentation in various languages in folders named for each language: English, French, German, Spanish, Italian, Dutch, and Chinese. Check the CD-ROM folders to find out if applications and user documentation are available in a particular language.

File names include one of the following codes that indicate the language of the data contained in the file as shown below.

English: e, French: f, German: g, Spanish: sp, Italian: i, Dutch: du, Chinese: ct

If your language is not included in the above, use the contents of the “English” folder.

## Installing Software

Use the following procedures to install the software. We recommend that you install Internet Explorer and Outlook Express first before installing Photo Loader and Acrobat Reader.

■ **To install Internet Explorer and Outlook Express**

1. Open the file named “Internet Explorer.”
2. Open the folder for the language version you want to install, and then open the file named “readme\_casio” file.
3. Follow the instructions in the read me file to install Internet Explorer and Outlook Express.

■ **To install Photo Loader**

1. Open the folder named “Photo Loader.”
2. Open the folder named “English,” and then open the file named “Important.”
3. Open the folder named “Installer,” and then open the file named “readme.”
4. Follow the instructions in the “readme” file to install Photo Loader.

»» **IMPORTANT!** ««

- If you are upgrading to the new version of Photo Loader from a previous version and you want to use library management data and HTML files created using the old version of Photo Loader, be sure to read the “Important” file in the “Photo Loader” folder. Follow the instructions in the file to use your existing library management files. Failure to follow this procedure correctly can result in loss or corruption of your existing files.

■ **To install Acrobat Reader**

1. On the bundled CD-ROM, open the folder named “Acrobat Reader.”
2. Open the folder for the language whose version of Acrobat Reader you want to install, and then open the file named “readme\_casio.”
  - Follow the instructions in the read me file to install Acrobat Reader.

## ■ Installing the USB Driver

1. Turn off the camera and quit all applications on your Macintosh.
2. Insert the bundled CD-ROM provided into the CD-ROM drive.
3. Open the hard disk that is specified as the startup disk.
4. Open the “System Folder” on the startup disk.
5. Open the “Extensions” folder inside the “System Folder.”
6. Open the “USB Driver” folder on the CD-ROM.
7. Drag “CASIO-USB Storage Driver” and “CASIO-USB Storage Class Shim” from the “USB Driver” folder to the “Extensions” folder.
8. Confirm that the “CASIO-USB Storage Driver” file and “CASIO-USB Storage Class Shim” file are in the “Extensions” folder, and then restart your Macintosh.

9. After the system starts up, use the USB cable to connect the camera to your Macintosh.

10. Turn on the camera.

11. From now on, the camera will be recognized as a drive whenever you connect the camera to your Macintosh.

- The shape of the icon that appears on your Macintosh display depends on the version of your Mac OS.

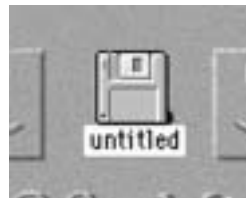

### »» IMPORTANT! ««

- If you are running an operating system other than Mac OS 9 or Mac OS X, do not connect the camera to your Macintosh PC without installing the USB driver first.
- **To uninstall the USB driver**  
Delete “CASIO-USB Storage Driver” and “CASIO-USB Storage Class Shim” from the “Extensions” folder.

## Viewing User Documentation (PDF Files)

To perform the following procedures, you must have Acrobat Reader installed on your Macintosh (page 86).

1. On the bundled CD-ROM, open the folder named “Acrobat Reader.”
2. Open the folder for the language whose version of Acrobat Reader you want to install, and then open the file named “readme\_casio.”
3. Follow the instructions in the read me file to install Acrobat Reader.

### ■ To view the camera user’s guide

1. On the CD-ROM, open the “Manual” folder.
2. Open the “Digital Camera” folder, and then open the folder for the language whose user’s guide you want to view.
3. Open the file named “camera\_xx.pdf.”
4. “xx” is the language code (English: e, French: f, German: g, Spanish: sp, Italian: i, Dutch: du, Chinese: ct).

### ■ To read the Photo Loader user’s guide

1. On the CD-ROM, open the “Manual” folder.
2. Open the “Photo Loader” folder and then open the “English” folder.
3. Open “PhotoLoader\_english.”



### Transferring Files to a Computer

The CD-ROM that comes bundled with your camera contains a copy of Photo Loader and a USB driver. This software lets you transfer the contents of the camera's memory to your computer quickly and easily. Photo Loader and the Photohands application can also be used for high-level image management and editing.

- For information about using Photo Loader and Photohands, see their user documentation files (PDF) on the bundled CD-ROM.

### Transferring Files Over a USB Connection

Connecting the bundled USB cradle to a computer that is equipped with a USB port makes it possible to transfer files to a computer simply by placing the camera onto the cradle.

- Note that you need to install a USB driver on your computer (page 81). Once you use the cradle to establish a USB connection, the computer sees the camera as an external storage device (card reader/writer).
- If you plan to transfer files from the camera's built-in memory to your computer, make sure there is no memory card loaded in the camera. If there is, remove the memory card from the camera before you place it onto the cradle.

#### NOTE

- Do not install USB driver from the CD-ROM onto a computer running Windows XP, or Mac OS 9 or Mac OS X. With these operating systems, USB communication becomes enabled simply by connecting the camera to the computer with the USB cable.

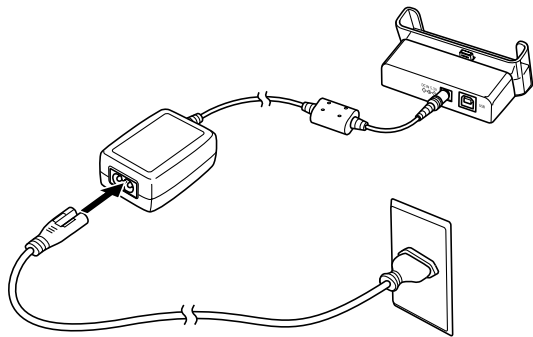

4. Shut down your computer, and plug Connector A of the cable into its USB port. Next, start up your computer.



## USING THE CAMERA WITH A COMPUTER

### 5. Turn off the camera and remove its connector cover.

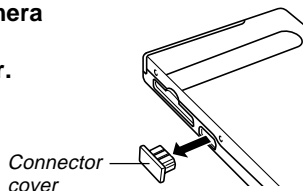

### 6. Making sure that the camera is turned off, set it onto the USB cradle.

- Do not place the camera onto the USB cradle while it is turned on.

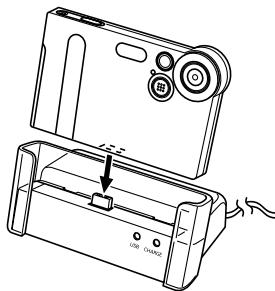

### 7. Turn on the camera.

- When you turn on the camera, it enters the USB Mode and automatically transfers the files in camera memory to the computer.
- While the camera is in the USB Mode, the USB lamp on the cradle lights green (page 109).

### ▶▶ IMPORTANT! ◀◀

- Be sure to read the applicable information in the user documentation that comes with your computer before connecting the USB cradle.
- Do not leave the same image displayed on your computer screen for a long time. Doing so can cause the image to "burn in" on the screen.
- Take care when connecting the USB cable to the USB cradle. The USB port and the cable plug are shaped for proper positioning.
- Plug the USB cable into the ports securely as far as it will go. Proper operation is not possible if connections are not correct.
- Be sure to connect the AC adaptor to the USB cradle to supply power to the camera.
- The optionally available CASIO QC-1U USB cable cannot be used with this camera.
- Never disconnect the USB cable while the PC is accessing camera memory (indicated by a flashing USB lamp). Doing so can cause data to become corrupted.
- You can perform data communication in either the REC mode or PLAY mode.

### ■ Terminating a USB Connection

#### **Windows XP, Me or 98**

Turn off the camera, and then remove the camera from the USB cradle.

#### **Windows 2000**

Click card services in the task tray on your computer screen, and disable the drive number assigned to the camera. Next, turn off the camera, and then remove the camera from the USB cradle.

#### **Macintosh**

In Finder, drag the camera to the Trash. Next, turn off the camera, and then remove the camera from the USB cradle.

### Using a Memory Card to Transfer Images to a Computer

The procedures in this section describe how to transfer images from the camera to your computer using a memory card.

#### **Using a Computer with a Built-in SD Memory Card Slot**

Insert the SD memory card directly into the slot.

#### **Using a Computer with a Built-in PC Card Slot**

Use a commercially available PC card adapter (for an SD memory card/MMC). For full details, see the user documentation that comes with the PC card adapter and your computer.

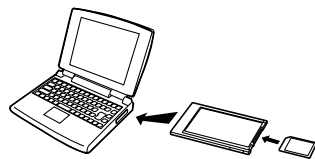

### Using a Commercially Available SD Memory Card Reader/Writer

See the user documentation that comes with the SD memory card reader/writer for details about how to use it.

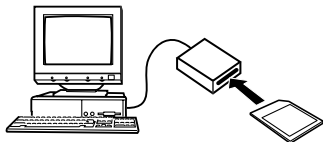

### Using a Commercially Available PC Card Reader/Writer and PC Card Adapter (for SD Memory Cards and MMCs)

See the user documentation that comes with the PC card reader/writer and PC card adapter (for an SD memory card/MMC) for details about how to use them.

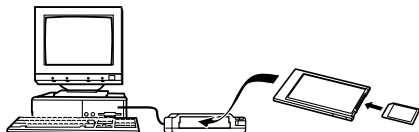

## Memory Data

Images recorded with this camera and other data are stored in memory using DCF (Design Rule for Camera File System) protocol. DCF protocol is designed to make it easier to exchange image and other data between digital cameras and other devices.

### ■ DCF Protocol

DCF devices (digital cameras, printers, etc.) can exchange images with each other. DCF protocol defines camera format for image file data and the directory structure for camera memory, so images can be viewed using another manufacturer's DCF camera or printed on a DCF printer.

## Memory Directory Structure

### ■ Directory Structure

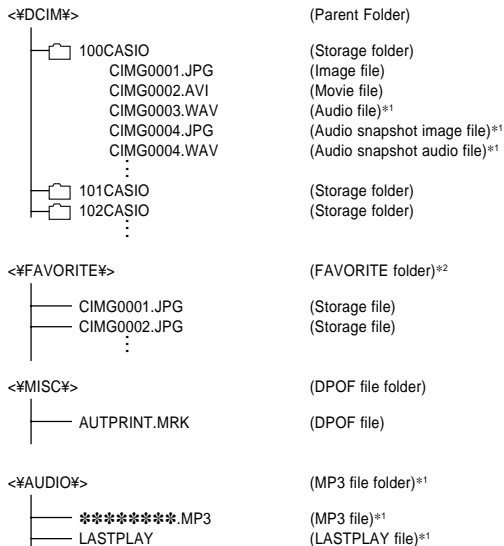

\*1 These folders and files are for the EX-M2 only.

\*2 These folders are created in built-in memory only.

### ■ Folder and File Contents

- Parent folder  
Folder that stores all of the digital camera files.
- Storage folder  
Folders for storing files stored with the digital camera.
- Image file  
File that contains an image recorded with the digital camera.
- Movie file  
File that contains a movie recorded with the digital camera.
- Audio file  
File that contains an audio recording.
- Audio snapshot image file  
File that contains the image part of an audio snapshot.
- Audio snapshot audio file  
File that contains the audio part of an audio snapshot.
- FAVORITE folder  
Folder that contains Favorites image files.
- DPOF file folder  
Folder that contains DPOF files.
- MP3 files folder  
Folder that contains MP3 files.
- LASTPLAY file  
File that contains information about the last played MP3 file.

### Image Files Supported by the Camera

- Image files recorded with the CASIO EX-S2/EX-M2 Digital Camera
- DCF protocol image files

Certain DCF functions may not be supported. When displaying an image recorded on another camera model, it may take a long time for the image to appear on the display.

### Built-in Memory and Memory Card Precautions

- Note that the folder named “DCIM” is the parent (top) folder of all the files in memory. When transferring memory contents to a hard disk, MO disk, or other external storage, treat all the contents inside a DCIM folder as a set and always keep them together. You can change the name of the DCIM folder on your computer. Changing the name to a date is a good way to keep track of multiple DCIM folders. However, be sure you change the name of the DCIM folder back to “DCIM” before you copy it back to memory for playback on the camera. The camera does not recognize any folder name other than DCIM.
- We also strongly recommend that after transferring data from memory to other external storage that you reformat memory and delete its contents before using it to store more files. Remember that formatting memory deletes all of its contents. Check to make sure that you no longer need any of the files in memory before you format it.

# PLAYING AN AUDIO FILE (EX-M2 Only)

You can transfer MP3 music data files from your computer to the camera and then use the camera as a portable audio player.

- MP3 stands for MPEG Audio Layer-3, which is the name of audio compression technology.
- Supported Files  
MPEG-1 Audio Layer-3  
Bit Rate: 32 to 320 kbps, VBR-compatible  
Sampling Frequencies: 32, 44.1, 48kHz
- Maximum Number of Playback Files: 999

## ▶▶ IMPORTANT! ◀◀

- Depending on the MP3 file format, some music data may not be playable.
- A bit rate of 128kbps and a sampling frequency of 44.1kHz are recommended for MP3 files.
- It is up to you to obtain software for creating MP3 files and to create the MP3 files you want to play.

## Transferring Audio Files to the Camera

- 1. Establish a connection between the camera and your computer (page 89).**
- 2. Transfer the MP3 files from your computer to the camera's AUDIO file.**
  - If you cannot find a folder named AUDIO in camera memory, create one at the location indicated under "Memory Directory Structure" on page 94.



## Preparing the Camera for Audio Player Operation

Perform the following steps to prepare the camera for operation as an audio player.

1. Turn off the camera and remove its connector cover.

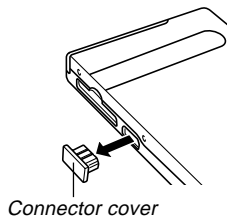

2. Connect the LCD remote controller to the camera's connector, and then plug the stereo headphones into the Headphones jack of the LCD remote controller.

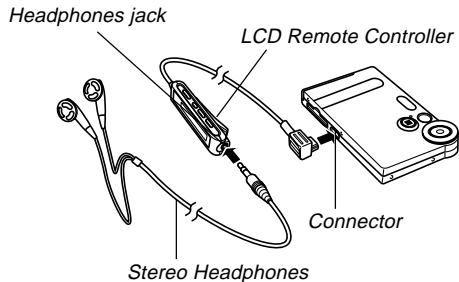

3. Align the mode selector with "AUDIO".

- This enters the AUDIO mode for playback audio data.
- Press the [▶/■] button on the LCD remote controller to turn on the camera and start playback.

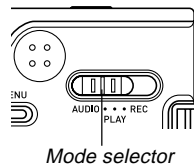

### ▶▶ IMPORTANT! ◀◀

- All remote controller buttons are disabled when the camera's mode selector is set to "REC" or "PLAY".
- The camera's monitor screen is off while the camera is in the AUDIO mode. Except for the power button, all other camera buttons are disabled.
- Never try to connect any other type of remote controller besides the one that comes with the camera. Also, never try to use the supplied remote controller with any other type of device.
- You cannot play MP3 file data through the camera's built-in speaker.

## Using the Camera as an Audio Player

### General Guide

#### ● LCD Remote Controller

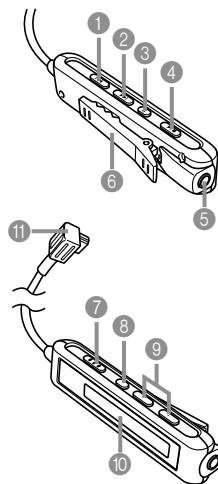

- 1 [◀◀] (Skip Back/Fast Reverse)
- 2 [▶▶] (Skip Forward/Fast Forward)
- 3 [||] (Pause)
- 4 [▶/■] (Play/Stop)
- 5 Headphones jack (ø3.5mm stereo mini jack)
- 6 Clip
- 7 Lock switch
- 8 Playback mode button
- 9 Volume buttons
- 10 LCD
- 11 Camera connector

## PLAYING AN AUDIO FILE (EX-M2 Only)

### ● Display

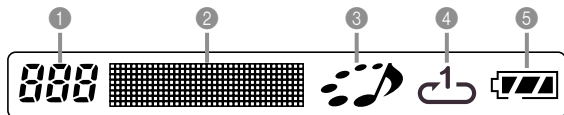

- 1 Track number**  
Shows the track number of the current track.
- 2 Track name, artist name, playback time, volume level**
  - Shows the ID3 tag (ID3V1), which is the track name and artist name (alphabetic characters only), contained in the file.
  - During fast forward and fast reverse, shows the elapsed play time.
  - During volume level adjustment, shows the current volume level.
- 3 Playback status indicator**  
This icon indicates the current playback status.

This type of icon:	Indicates this:
Rotation clockwise while flashing	Playback is in progress.
Flashing	Playback is paused.
Steady and unmoving	Playback is stopped.

- 4 Playback mode indicator**  
This icon indicates the playback mode.

This type of icon:	Indicates this:
Off	Normal playback
	All track repeat
	1-track repeat

- 5 Battery level indicator**

## Basic Remote Controller Operations

### ● To start playback

Press the [▶/■] button. The remote controller beeps to indicate that playback has started.

- Pressing the [▶/■] button while the camera is off turns on power and starts playback.

### ● To pause playback

Press the [||] button (remote controller beeps).

Pressing the [▶/■] button resumes playback (remote controller beeps).

- If you leave playback paused for about two minutes, the camera and remote controller turn off automatically.

### ● To fast forward the playback

Hold down the [▶▶] button for a few seconds until fast forward starts.

### ● To fast reverse the playback

Hold down the [◀◀] button for a few seconds until fast reverse starts.

### ● To skip to the beginning of the current track

Press the [◀◀] button (remote controller beeps).

To skip to the beginning of a previous track, press the [◀◀] button multiple times (remote controller beeps). The current track number is shown on the LCD.

### ● To skip to the beginning of the next track

Press the [▶▶] button (remote controller beeps).

To keep skipping forward, press the [▶▶] button multiple times (remote controller beeps). The current track number is shown on the LCD.

### ● To stop playback

Press the [▶/■] button (remote controller beeps).

### ● To adjust volume

Press the [+] or [-] volume buttons to adjust volume to the desired level. The LCD shows the current volume level.

### ● To turn off power

Press the camera's power button.

- Camera power also turns off automatically if you do not perform an operation for about 10 seconds after playback is stopped.



### ▶▶ IMPORTANT! ◀◀

- The button operation tone does not sound if the camera's button tone function is turned off (page 72).
- You cannot use fast forward, fast reverse, or skip while the current volume level is shown on the LCD.

## Specifying the Audio Playback Mode

You can use the following procedure to select one of three playback modes: normal playback, all-track repeat, or 1-track repeat.

- In the AUDIO mode, start audio playback.**
  - The initial default mode is normal playback.
- Press the remote controller's playback mode button to cycle through the playback modes. The playback mode indicator on the LCD indicates the currently selected mode.**

To do this:	Select this mode:	Which is indicated by this icon:
Play all tracks in order and then stop	Normal	Off
Play all tracks in order in an endless loop	All-track repeat	
Play the current track in an endless loop	1-track repeat	

## Selecting a Specify Track for Playback

You can use the following procedure to display a list of available tracks and select one of them for playback.

- While AUDIO mode playback is stopped or paused, click the camera's controller.**

- This turns on the monitor screen, which shows a list of information about each track, including track number, track name, and play time.

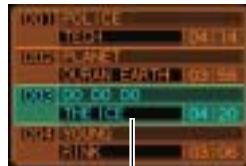

*Currently selected track*

- Rock the controller up or down to move the highlighting to the track you want to select.**
  - If move the highlighting to the top or the bottom of the list, the list will scroll to show other tracks.

## Specifying the Track Playback Sequence

Normally, all tracks in memory are played back in the order they are saved. You can use the following procedure to create a play list that tells the camera the sequence to use when playing back AUDIO mode tracks.

- 1. On your computer, use your word processor or another text editor to create a file named "PLAYLIST.TXT".**
- 2. Configure the play list by specifying the tracks you want to play in the sequence you want to play them.**

- See "Example PLAYLIST.TXT File Contents" on page 103 for information about how to create a "PLAYLIST.TXT" file.

## ■ Example Folder Structure

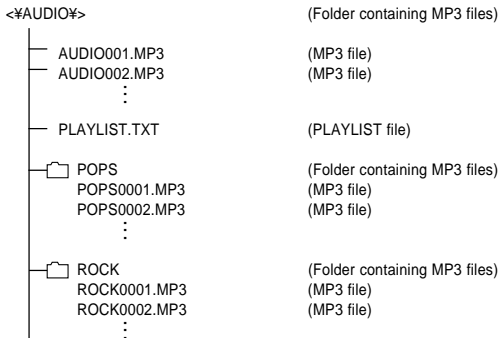

## ■ Example PLAYLIST.TXT File Contents

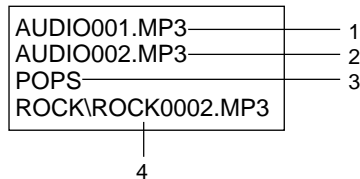

The above PLAYLIST.TXT file specifies the following playback sequence.

1. Playback the MP3 file named AUDIO001.MP3.
2. Playback the MP3 file named AUDIO002.MP3.
3. Playback all the files in the folder named POPS.
4. Playback the MP3 file named ROCK0002.MP3, which is located in folder named ROCK.

▶▶ NOTES ◀◀

- If there is no PLAYLIST.TXT file in the camera's AUDIO folder, all tracks are played back in the order they are saved in memory.
- Playback of any tracks that are not included in the PLAYLIST.TXT file is skipped.
- To change to a different playback sequence, replace PLAYLIST.TXT with another PLAYLIST.TXT file.
- When there is a PLAYLIST.TXT file in the AUDIO folder, only the tracks in the file appear on the camera's monitor screen.

## Disabling Remote Controller Button Operations

The remote controller has a lock switch that you can use to disable button operations to guard against accidental operation. To disable all remote controller button operations, slide the lock switch in the direction indicated by the ► mark.

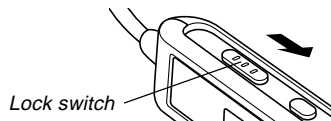

- To re-enable remote controller button operations, slide the lock switch back in the other direction.

▶▶ NOTE ◀◀

- The camera's power button continues to be operational, even while remote controller button operations are disabled.



### LCD Remote Control Error Messages

The following describes the error messages that appear on the LCD remote controller's display.

	Cause	Action
<b>NoData</b>	Playback attempted when there is no MP3 data in memory.	Transfer MP3 file data to the "AUDIO" folder of built-in memory or the memory card.

### Audio Playback Precautions

- Listening to audio at a high volume for long periods can damage your hearing. Particular care is required when first starting a playback operation.
- Never use the headphones, try to perform fine adjustment, or look at the monitor screen while driving a car, riding a motorcycle, or operating any other type of motor vehicle. Doing so creates the risk of traffic accident. When walking, take special care to remain aware of traffic and road conditions around you.

# APPENDIX











## Menu Reference





The following shows lists of menus that appear in the REC mode and PLAY mode, and their settings.

- The settings that are underlined in the following table are initial defaults.

### ■ REC Mode

#### ● REC tab menu

REC Mode	EX-S2:  (Snapshot) /  (Best Shot) /  (Movie)
	EX-M2:  (Snapshot) /  (Best Shot) /  (Movie) /  (Snapshot Audio) /  (Voice Recording)
Flash	<u>Auto</u> /  (Flash Off) /  (Flash On) /  (Red-eye reduction)
Self-timer	10 sec / <u>Off</u>
Indicators	<u>LCD-ON</u> / LCD-OFF
Size	<u>1600 x 1200</u> / 1280 x 960 / 640 x 480
Quality	Fine / <u>Normal</u> / Economy
Digital Zoom	<u>On</u> / Off
Review	On / <u>Off</u>
EV Shift	-2.0 / -1.7 / -1.3 / -1.0 / -0.7 / -0.3 / <u>0.0</u> / +0.3 / +0.7 / +1.0 / +1.3 / +1.7 / +2.0

White Balance	<u>Auto</u> /  (Sunlight) /  (Shade) /  (Light Bulb) /  (Fluorescent) / Manual
L/R Key	<u>REC Mode</u> / EV shift / Flash / White Balance / Off

#### ● Memory tab menu

REC Mode	On / <u>Off</u>
Flash	<u>On</u> / Off
Digital Zoom	<u>On</u> / Off
White Balance	On / <u>Off</u>

#### ● Set Up tab menu

Beep	<u>On</u> / Off
Startup	On / <u>Off</u>
Date Style	<u>YY/MM/DD</u> / DD/MM/YY / MM/DD/YY
Adjust	Time setting
Language	日本語 / <u>English</u> / Français / Deutsch / Español / Italiano
Format	Format / <u>Cancel</u>

## ■ PLAY Mode

### ● PLAY tab menu

Zoom	
Protect	<u>On/Off</u> / All Files : On/Off / Cancel
Dubbing	*EX-M2 only
Resize	<u>640 x 480</u> / 320 x 240 / Cancel
Copy	Built-in → Card / Card → Built-in / Cancel
Favorites	<u>Show</u> / Save / Delete / Cancel

### ● Set Up tab menu

Beep	<u>On</u> / Off
Startup	<u>On</u> / Off
Date Style	<u>YY/MM/DD</u> / DD/MM/YY / MM/DD/YY
Adjust	Time setting
Language	日本語 / <u>English</u> / Français / Deutsch / Español / Italiano
Format	Format / <u>Cancel</u>

## Indicator Lamp Reference

### Camera Indicator Lamps

The camera has two indicator lamps: an operation/flash charge lamp and a self-timer lamp. These lamps light and flash to indicate the current operational status of the camera.

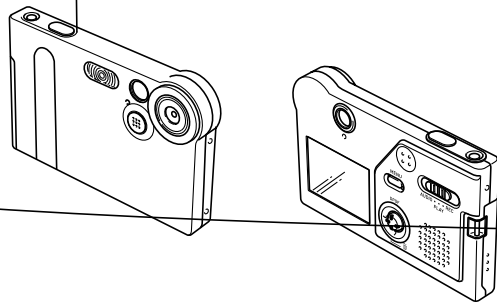

\* There are two lamp flash patterns. Pattern 1 flashes once per second, while Pattern 2 flashes twice per second. The table below explains what each flash pattern indicates.

## ■ REC Mode

Operation/Flash Charge Lamp		Self-timer Lamp		Meaning
Color	Status	Color	Status	
Green	Lit			Power on
Amber	Pattern 1			Flash charging
Green	Lit			Monitor screen off
Green	Pattern 2			Storing image
Green	Pattern 1	Red	Pattern 1	Self-timer countdown (10 to 3)
Green	Pattern 2	Red	Pattern 2	Self-timer countdown (3 to 1)
Red	Lit			Memory error
Red	Lit			Memory full
Red	Pattern 1			Low battery alert
Red	Pattern 1			Monitor screen disabled
Green	Pattern 2			Powering down

### ▶▶▶ IMPORTANT! ◀◀◀

- Never remove the memory card from the camera while the operation/flash charge lamp is flashing. Doing so will cause recorded images to be lost.

## ■ PLAY Mode

Operation/Flash Charge Lamp		Self-timer Lamp		Meaning
Color	Status	Color	Status	
Green	Lit			Power on
Green	Pattern 2			Deleting image
Red	Lit			Memory error
Red	Pattern 1			Low battery alert
Green	Pattern 2			Formatting
Green	Pattern 2			Powering down

## ■ AUDIO Mode (EX-M2 only)

Operation/Flash Charge Lamp		Self-timer Lamp		Meaning
Color	Status	Color	Status	
Green	Lit			Power on, LCD remote controller not connected

## or Lamps

Indicator lamps: a CHARGE lamp  
lamps light and flash to indicate the  
of the cradle and camera.

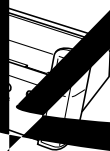

Lamp	Meaning
Status	U

Red	Lit		
Green	Lit		
Amber	Lit		
Red	Flashing		
		Green	
		Green	F

## Troubleshooting Guide

	Symptom	Possible Cause	Action
Power Supply	Power does not turn on.	The battery is dead.	Charge the battery (page 24). If the battery goes dead soon after being charged, it means the battery has reached the end of its life and needs to be replaced. Purchase a separately available NP-20 rechargeable lithium ion battery.
	Camera suddenly powers down.	1) Auto Power Off activated (page 29). 2) The battery is dead.	1) Turn power back on. 2) Charge the battery (page 24).
Image Recording	Image is not recorded when the shutter release button is pressed.	1) Mode selector is set to "PLAY" or "AUDIO". 2) Flash unit is being charged. 3) Memory is full.	1) Align the mode selector with "REC". 2) Wait until the flash unit finishes charging. 3) Transfer files you want to keep to your computer and then delete files from camera memory, or use a different memory card.
	Camera powers down during self-timer countdown.	The battery is dead.	Charge the battery (page 24).
	Recorded images are not saved in memory.	1) Camera powers down before the save operation is complete. 2) Removing the memory card before the save operation is complete.	1) When the battery indicator shows  , charge the battery as soon as possible (page 24). 2) Do not remove the memory card before the save operation is complete.

## APPENDIX

	Symptom	Possible Cause	Action
Playback	Color of the playback image is different from the image on the monitor screen during recording.	Sunlight or light from another source is shining directly into the lens during recording.	Position the camera so sunlight does not shine directly into the lens.
	Images are not displayed.	A memory card with non-DCF images recorded with another camera is loaded in the camera.	This camera cannot display non-DCF images recorded onto a memory card using another digital camera.
Audio Playback	Cannot playback audio, cannot hear audio, or cannot control the audio playback using the remote controller.	<ol style="list-style-type: none"> <li>1) Mode selector is set to "REC" or "PLAY".</li> <li>2) There is no MP3 file data in memory. This is indicated by the message "NoData" on the remote controller LCD.</li> <li>3) Stereo headphones are not connected correctly.</li> <li>4) Volume setting is too low.</li> <li>5) The battery is dead.</li> <li>6) The remote controller buttons are locked.</li> <li>7) There are no playable files.</li> <li>8) Improper PLAYLIST.TXT file contents</li> </ol>	<ol style="list-style-type: none"> <li>1) Align the mode selector with "AUDIO".</li> <li>2) Transfer MP3 files to the camera's AUDIO folder.</li> <li>3) Correctly connect the headphones to the headphones jack.</li> <li>4) Adjust the volume to a higher level.</li> <li>5) Charge the battery (page 24).</li> <li>6) Slide the remote controller lock switch in the opposite direction of the arrow marking to unlock the controls.</li> <li>7) Check the files you are trying to play (page 96).</li> <li>8) Check to make sure the PLAYLIST.TXT file lists the MP3 files you want to play.</li> </ol>
	Playback time is short.	The battery is dead.	Charge the battery (page 24).

\* Note that audio player capabilities are available with the EX-M2 only.

## APPENDIX

	Symptom	Possible Cause	Action
Other	All buttons and switches are disabled.	Circuit problem caused by electrostatic charge, impact, etc. while the camera was connected to another device.	Remove the battery from the camera, reinsert it, and then try again.
	Monitor screen is off.	<ol style="list-style-type: none"> <li>1) "LCD-OFF" is selected for the "Indicators" setting on the REC tab.</li> <li>2) USB communication is in progress.</li> </ol>	<ol style="list-style-type: none"> <li>1) On the REC tab menu, change the "Indicators" setting to "LCD-ON" (page 51).</li> <li>2) After confirming that the computer is not accessing camera memory, disconnect the USB cable.</li> </ol>
	Cannot transfer files over a USB connection.	<ol style="list-style-type: none"> <li>1) Camera is not set securely on the USB cradle.</li> <li>2) USB cable is not connected securely.</li> <li>3) USB driver is not installed.</li> <li>4) Camera is turned off.</li> </ol>	<ol style="list-style-type: none"> <li>1) Check the connection between the camera and USB cradle.</li> <li>2) Check all connections.</li> <li>3) Install the USB driver on your computer (page 81).</li> <li>4) Turn on the camera.</li> </ol>



## Display Messages

---

**Memory Full** Memory is full. If you want to record more files, delete files you no longer need (page 62).

---

**Record Error** Image compression could not be performed during image data storage for some reason. Record the image again.

---

**Folder cannot be created.** This message appears when you try to record an image while there are 9,999 files stored in the 999th folder. If you want to record more files, delete files you no longer need (page 62).

---

**The card is locked.** The LOCK switch of the SD memory card is locked. You cannot store images to or delete images from a memory card that is locked.

---

**There are no files.** There are no files in built-in memory or on the memory card.

---

**This file cannot be played.** The image file or audio file is corrupted, or is a type that cannot be displayed by this camera.

---

**No Favorites file!** There is no FAVORITE file.

---

**This function cannot be used.** You attempted to copy files from built-in memory to a memory card while there is no memory card loaded in the camera (page 79).

---

**Battery is low.** The battery is dead.

---



---

**File could not be saved because battery is low.** The battery is dead, so the recorded image or audio recording file could not be saved.

---

**The card is not formatted.** The memory card is not formatted. Format the memory card (page 78).

---

**Card ERROR** Some problem occurred with the memory card. Turn off the camera, and remove and then re-insert the memory card. If the same message appears, format the memory card (page 78).

---

**»» IMPORTANT! ««**

Formatting the memory card deletes all files on the memory card. Before formatting, try transferring recoverable files to a computer or some other storage device.

---

**The function is not supported for this file.** The function you are trying to perform is not supported for the file on which you are trying to perform it.

---

**SYSTEM ERROR** Your camera system is corrupted. Contact your retailer or a CASIO authorized service center.

---

## Specifications

### Main Specifications

**Product** ..... Digital Camera

**Model** ..... EX-S2/EX-M2

### ■ Camera Functions

#### Image Files Format

Snapshots: ..... JPEG (Exif Version 2.2); DCF (Design Rule for Camera File System)1.0 standard; DPOF compliant

Movies: ..... AVI (Motion JPEG)

Audio: ..... WAV (EX-M2 only)

**Recording Media:** ..... 12MB built-in flash memory  
SD Memory Card  
MultiMedia Card

#### Image Size

Snapshots: ..... 1600 x 1200pixels  
1280 x 960pixels

640 x 480pixels

Movies: ..... 320 x 240pixels

### Approximate Memory Capacity and File sizes

#### • Snapshots

File Size (pixels)	Quality	Approximate Image File Size	Built-in flash memory 12MB	SD Memory Card* 64MB
1600 x 1200 (UXGA)	Fine	900KB	11 shots	60 shots
	Normal	630KB	16 shots	85 shots
	Economy	370KB	29 shots	154 shots
1280 x 960 (SXGA)	Fine	680KB	15 shots	82 shots
	Normal	460KB	24 shots	126 shots
	Economy	250KB	42 shots	220 shots
640 x 480 (VGA)	Fine	190KB	56 shots	294 shots
	Normal	140KB	74 shots	386 shots
	Economy	90KB	118 shots	618 shots

#### • Movies (320 x 240 pixels)

Data Size	150KB/second max.
Recording Time	One Movie: 30 seconds maximum Total Movie Time: 80 seconds maximum (built-in memory) 410 seconds maximum (SD 64MB memory card)*

\* Based on Matsushita Electric Industrial Co., Ltd. products. Capacity depends on card manufacturer.

\* To determine the number of images that can be stored on a memory card of a different capacity, multiply the capacities in the table by the appropriate value.

## APPENDIX

<b>Delete</b> .....	Single-file, all files (with protection)
<b>Effective Pixels:</b> .....	2.0 million
<b>Imaging Element:</b> .....	1/1.8-inch square pixel color CCD (Total pixels: 2.11 million)
<b>Lens/Focal Distance</b> .....	F3.2/f = 7.5mm (Equivalent to 36mm on a 35mm film camera.)
<b>Zoom</b> .....	4X digital zoom
<b>Focusing</b> .....	Fixed focal point
<b>Approximate Focus Range (from lens surface)</b> .....	1m to $\infty$
<b>Exposure Control</b>	
Metering: .....	Multi-pattern by imaging element
Exposure: .....	Program AE
Exposure Compensation: ...	-2EV to +2EV (in 1/3EV steps)
<b>Shutter</b> .....	CCD shutter, mechanical shutter 1/4 to 1/7000 second
<b>Aperture:</b> .....	F3.2 fixed
<b>White Balance</b> .....	Automatic/fixed (4 modes) /Manual
<b>Self-timer</b> .....	10 seconds
<b>Built-in Flash</b>	
Flash Modes: .....	Auto, Off, On, Red-eye reduction
Approximate Flash Range: ...	1 meter to 2 meters

<b>Recording Functions</b> .....	Snapshot (with audio for EX-M2 only); self-timer; Best Shot; Movie (with audio for EX-M2 only); voice recording (EX-M2 only) * Audio is monaural
<b>Audio Recording Time (EX-M2 only)</b>	
Audio Snapshot: .....	Approximately 30 seconds maximum per image
Voice Recording: .....	Approximately 50 minutes with built-in memory
After Recording: .....	Approximately 30 seconds maximum per image
<b>Monitor Screen</b> .....	1.6-inch TFT color LCD 84,960 pixels (354 x 240)
<b>Viewfinder</b> .....	Monitor screen and optical viewfinder
<b>Timekeeping Functions</b> ...	
Built-in quartz digital clock	
Date and Time: .....	Recorded with image data
Auto Calendar: .....	To 2049
<b>Input/Output Terminals</b> ...	Cradle connector (EX-M2 connector is also used for connection of remote controller.)
<b>Speaker</b> .....	20mm round, monaural (EX-M2 only)

## ■ Audio Player Function (EX-M2 Only)

### Data Compression/

Decompression ..... MP3 (MPEG-1 Audio Layer-3)

Sampling Frequencies ..... 32kHz, 44.1kHz, 48kHz

Bit Rates ..... 32 to 320 kbps, VBR-compatible

Play Mode ..... Normal, all track repeat, 1-track repeat

### Practical Maximum

Headphone Output ..... 9mW + 9mW (16 Ω)

A bit rate of 128kbps and a sampling frequency of 44.1kHz are recommended for MP3 files.

## ■ Power Supply

Power Requirements ..... Rechargeable lithium ion battery (NP-20) x 1

### Approximate Battery Life:

Continuous Recording	65 minutes (390 shots)
Continuous Playback (Continuous Snapshot Recording)	110 minutes
Continuous Voice Recording*	80 minutes
Continuous Audio Playback*	330 minutes

The values noted above are approximate values until power fails at normal temperature (25°C)(page 26). The above does not guarantee that you will be able to achieve this level of operation. Low temperatures shorten battery life. Voice recording times are based on continuous recording, while audio playback times are based on continuous output (through headphones).

\* Voice recording and audio playback times apply to the EX-M2 only.

Power Consumption ..... DC 3.7V Approximately 3.1W

## APPENDIX

### ■ Other

#### Dimensions

EX-S2: ..... 88(W) x 55(H) x 11.3(D) mm  
(3.5"(W) x 2.2"(H) x 0.4"(D))  
(excluding projections)

EX-M2: ..... 88(W) x 55(H) x 12.4(D) mm  
(3.5"(W) x 2.2"(H) x 0.5"(D))  
(excluding projections)

#### Weight

EX-S2: ..... Approximately 88 g (3.1 oz)  
(excluding battery and accessories)

EX-M2: ..... Approximately 90 g (3.2 oz)  
(excluding battery and accessories)

**Bundled Accessories** ..... Rechargeable lithium ion battery (NP-20); USB Cradle; Special AC Adaptor; AC power cord; Strap; Special USB cable; Dummy Card; Connector Cover; LCD Remote Controller (bundled with EX-M2 only); Stereo Headphones (bundled with EX-M2 only); CD-ROM; Basic Reference; Rechargeable Lithium Ion Battery User's Guide

### ■ USB Cradle

**Input/Output Terminals** .... Camera connector; USB port; AC adaptor terminal (DC IN 5.3V)

**Power Consumption** ..... DC 5.3V Approximately 3.4W

**Dimensions** ..... 95(W) x 55.5(H) x 39.5(D) mm  
(3.7"(W) x 2.2"(H) x 1.6"(D))  
(excluding projections)

**Weight** ..... Approximately 56 g (2.0 oz)

### ■ LCD Remote Controller (Bundled with EX-M2 Only)

**Input/Output Terminals** .... Camera connector; headphones jack (ø3.5mm stereo mini jack)

**Cord Length** ..... Approximately 0.8m (31.5")

**Dimensions** ..... 74.5(W) x 16(H) x 11(D) mm  
(2.9"(W) x 0.6"(H) x 0.4"(D))  
(excluding projections, excluding cradle)

**Weight** ..... Approximately 28 g (1.0 oz)

#### Power Supply

- Use only the special NP-20 rechargeable lithium ion battery to power this camera. Use of any other type of battery is not supported.
- This camera does not require a battery for the clock. The date and time settings of the camera are cleared whenever power supplied by both the battery and USB cradle is interrupted. Be sure to reconfigure these settings after power is interrupted (page 32).

#### LCD Panel

- The LCD panel is a product of the latest LCD manufacturing technology that provides a pixel yield of 99.99%. This means that less than 0.01% of the total pixels are defective (they do not turn on or always remain turned on).